



GERMAN-based company ●●●

EV Charging Station Catalogue





 Garching - Munich Manufacturing Facility / Germany



 Antalya Manufacturing Facility / Türkiye

Table of Contents

About Us	4
Vision - Mission	4
Product Series of Electric Vehicle Charging Stations	8
What are Electric Vehicle Charging Stations?	10
Type2 32A 5M Vehicle Charging Cable	12
22kW AC Electric Vehicle Charging Unit	14
30-400 kW DC High-Speed Electric Vehicle Charging Units	16-23
Energy Management System	24
Mobile and Web Application Features	26



In an increasingly complex world, we continuously adapt to changes and actively encourage all our partners to embrace our long-term goals and values through goal-oriented communication and mutual deep understanding of our mission. In this way, we aim to make a valuable contribution for future generations.

T e c h n o l o g y

Vision:

Our vision is to be a leader in the development of advanced solar energy technologies that maximize energy efficiency, preserve ecological balance, restore harmony between humans and nature, and accelerate the global transition to renewable energy to achieve the set climate goals.

Mission:

We are focused on continuous innovation and research to develop modern solar energy technologies and efficiently integrate them into smart home systems, enabling our customers to benefit from connected and sustainable energy usage.

Today:

Many customers are already benefiting from the modern installations we have seamlessly integrated into their homes. This allows them to optimize energy consumption, enabling instant savings and reducing their carbon footprint.

O p t i m i z a t i o n

“Through smart optimization solutions, we actively support the achievement of climate neutrality by increasing the most efficient use of solar energy worldwide.”

We are committed to developing and implementing advanced automation and control technologies to optimize energy consumption in homes and businesses, while significantly reducing operational costs.

Our customers' existing energy optimization systems have already resulted in significant improvements in emissions.

M a n u f a c t u r i n g

We aim to be a leading manufacturer of solar technologies, setting industry standards for quality and sustainability.

We are committed to producing high-quality and innovative solar products that meet the needs of the present while addressing future challenges. Through continuous improvements and investments in our production processes, we strive to maximize efficiency and minimize environmental impact.

Our customers are already benefiting from the advanced solar products manufactured in our state-of-the-art facilities. These products are not only efficient and reliable but also leading in terms of sustainability and environmental protection. The continuous optimization of our production processes guarantees products that are both economically and ecologically advantageous.

M i l e s t o n e s

We are pioneering solar technology that plays a crucial role in contributing to energy independence and climate resilience.

We drive transformative change in the global use of solar energy. By developing technologies that enable significant improvements in performance and ease of use, we are setting new standards.

Customers worldwide are using our technology, and together we are accelerating the transition to renewable energy while achieving both economic and ecological benefits.

A u t o m a t i o n

To drive the integration of intelligent automation solutions that make the interaction between solar technologies and end users seamless and intuitive.

To develop automation systems that not only operate smoothly but also adapt to consumer needs. These systems aim to optimize energy consumption, enhance operational efficiency, and accelerate the adoption of renewable technologies.

Our customers are enjoying the convenience and efficiency that our intelligent automation solutions bring to their daily lives. These technologies simplify the control of their energy supply, reduce costs, and support the transition to a more environmentally friendly future.



SOMPO



2014



60+



2

T r a n s p a r e n c y

Vision:

We aim to create an atmosphere of openness where everyone from our customers to our employees feels secure and well-informed.

Mission:

Clear information, no secrets that's our motto. Whether it's about the production of our products or how they function, we keep you constantly updated. We believe that well informed people make better decisions.

Today:

Our customers and partners benefit from our transparent business management. We ensure complete openness at every stage of our processes, from development to product delivery. This practice of open communication allows our stakeholders to make informed decisions and strengthens trust in long-term collaboration with our company.

E x p e r i e n c e

We want every interaction with our company to be a positive experience for customers and partners. Our products and services should not only be reliable and innovative but also inspire enthusiasm.

Our goal is to provide each customer and partner with a personalized and valuable experience. With our extensive experience in solar technology, we know what works and we use that knowledge to exceed your expectations and make the transition to sustainable energy easier for you.

Our customers benefit directly from our many years of experience in solar technology. We deliver tailored solutions that are reliable and efficient, supporting every step of the journey toward sustainable energy. Our team ensures a seamless experience through professional advice and assistance.

C o m m i t m e n t

Our vision is to be a leader in the solar industry through our unwavering commitment to quality and sustainability. We strive to improve in every aspect every day from product development to our services.

Our primary goal is to consistently exceed our customers' expectations. We are committed to the highest quality and continuous improvement of our products and services. Our dedication to sustainability and ethical business practices is unwavering and guides all our actions.

Our customers and partners can rely on our strong commitment. We employ innovative and sustainable technologies to ensure that our solutions are not only efficient but also environmentally friendly. Every project is executed with the highest standards of quality and a focus on long-term customer satisfaction.

H o m e S o l u t i o n

We aim to transform every home into an eco-friendly energy source. Our vision is to offer advanced solar solutions that are easy to integrate and optimize household energy consumption while contributing to global sustainability.

Our goal is to develop customized solar solutions tailored to the specific needs and conditions of each household. We are committed to providing our customers with the best combination of efficiency, ease of use, and economic benefit, making the transition to renewable energy simple and appealing.

Our Home Solution products enable customers to meet their energy needs sustainably while saving costs. Homes equipped with our technology benefit from intelligent energy management and a reduced carbon footprint. Our solutions are not only environmentally friendly but also user-friendly, allowing every household to fully harness the advantages of modern solar technology.

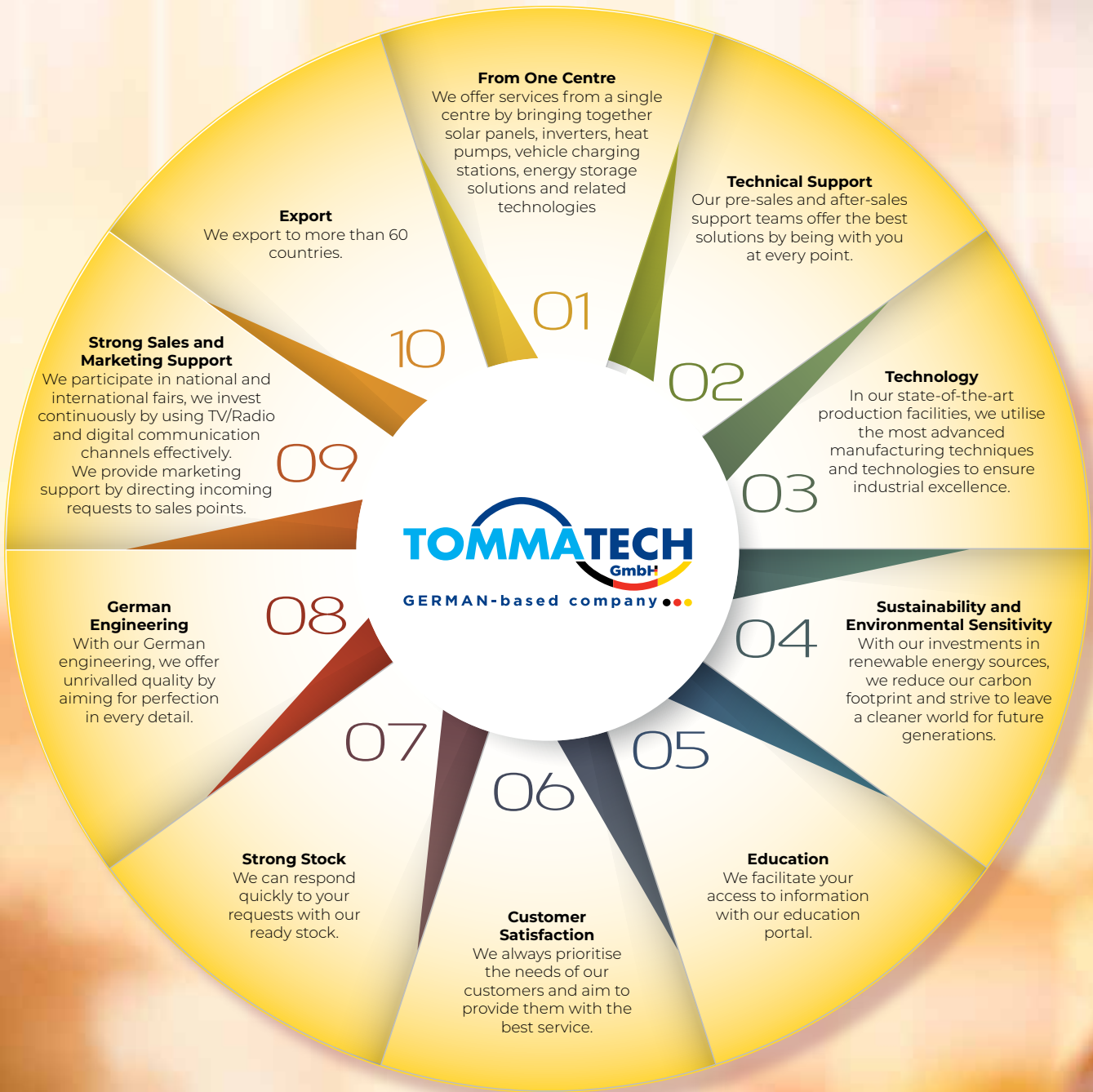

with TommaTech

You are in control!



**TYPE2 32A 5M
VEHICLE
CHARGING CABLE**

EVC-TT-TF-CBL-TYPE2



AC

22 KW AC LCD

Wireless

EVC-TT-AC-22KW-LCD



AC

22 KW AC LCD

With Panel

EVC-TT-AC-22KW-LCD-PN



DC

30 - 40 KW DC

EVC-TT-DC030...40KW-100...150A-1G



60 - 80 KW DC

EVC-TT-DC060...80KW-200...250A-1...2G



90 - 400 KW DC

EVC-TT-DC090...400KW-300...600A-1...2G

EVC-TT-DC180KW-400AV2-TF



WHAT IS AN ELECTRIC VEHICLE CHARGING STATION?

Electric vehicle charging stations are devices used to charge the batteries of electric vehicles. These stations provide electric vehicle users with charging capabilities at various locations, commonly in public or private areas. They come in different charging speeds and technologies. Electric vehicle charging stations play an essential role in reducing carbon emissions and decreasing reliance on fossil fuels.

TYPES OF ELECTRIC VEHICLE CHARGING STATIONS?

• AC CHARGING UNITS

AC vehicle chargers allow fast and straightforward charging of electric vehicles with different charging standards via Type II connectors. Smart and compact in design, these chargers (EVC) can be used both indoors and outdoors, offering an extensive operating temperature range.

• DC CHARGING UNITS

With the latest generation TommaTech high-speed electric vehicle charging stations featuring the innovative 400A booster technology, you can enjoy a rapid charging experience at 400A for up to 30 minutes.

WHERE ARE ELECTRIC VEHICLE CHARGING STATIONS USED?

Electric vehicle charging stations can be utilized in residential buildings, offices, businesses, or public areas. TommaTech chargers are fully compatible with TommaTech Trio and Uno Hybrid Inverters, enabling maximum efficiency from solar energy when used in combination with lithium battery applications.



ADVANTAGES OF TOMMATECH ELECTRIC VEHICLE CHARGING STATIONS?

- Fast, Safe, and Efficient Charging.
- **Cost Efficiency:** Electric vehicles offer significantly lower maintenance and fuel costs in the medium and long term.
- **Reduction of Greenhouse Gas Effects:** Contributing to the reduction of fossil fuel dependency and greenhouse gas effects. According to the 2016 World Wildlife Fund (WWF) report, using electric vehicles produces 63% fewer greenhouse gases.
- **Lower Carbon Emissions & Environmentally Friendly:** According to the International Council on Clean Transportation (ICCT), electric vehicles produce 81% fewer carbon emissions compared to vehicles running on fossil fuels.
- Our company prioritizes safety and customer satisfaction and provides comprehensive protection through the following insurance policies:
- **Installation Insurance:** Covers any damages and risks during the installation process.
- **Electronic Device Insurance:** Provides coverage against malfunctions or damages to electronic components and devices.
- **Product Liability Insurance:** Protects against third-party claims due to bodily or property damage arising from product defects.



TYPE2 32A 5M VEHICLE CHARGING CABLE

AC Vehicle Charging Cable



Electric Vehicle Charging Cable

The Type2 32A 5-meter charging cable enables rapid and secure charging of electric vehicles. With an output power of 22 kW, vehicles can be charged swiftly, while the current capacity of 32A ensures maximum efficiency. The cable is suitable for both indoor and outdoor applications, ideal for private and commercial use with 22 kW AC charging stations. It is highly flexible and practical in use. Manufactured from high-quality materials, this charging cable is durable and long-lasting, compatible with all Type2-compatible vehicles, and user-friendly.

Product Features



High Efficiency



100% Compatible with Solar Energy



Safe Charging Technology



24/7 Call Center Support



IP55 Protection Class



Suitable for Indoor and Outdoor Use

Connection Diagram

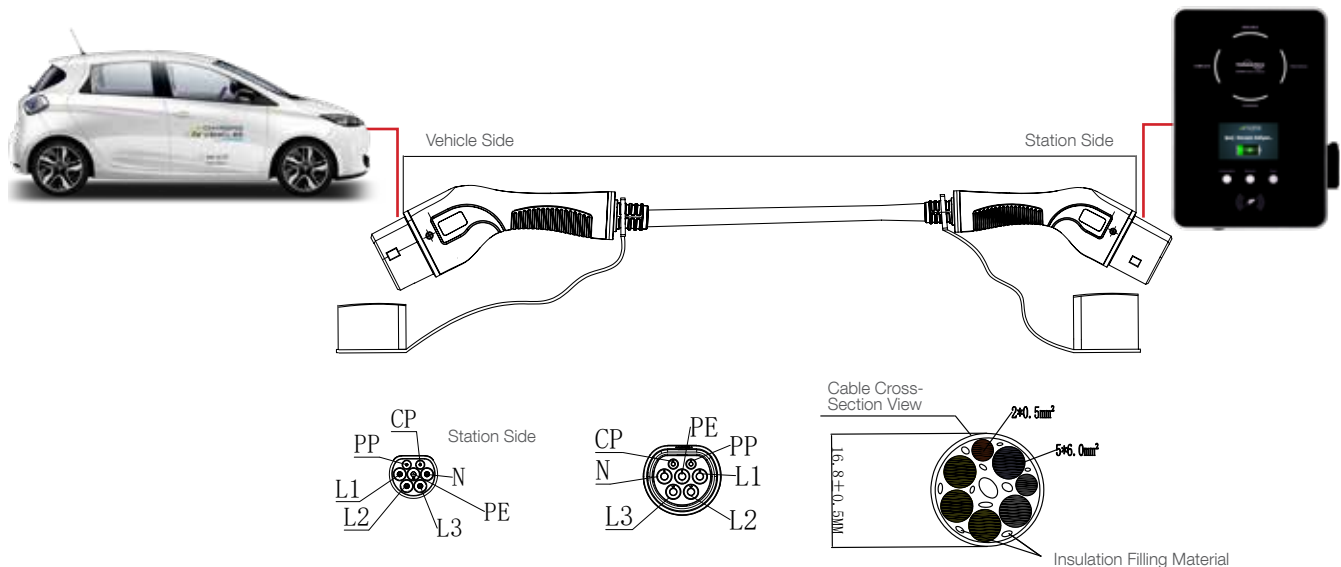

MODEL	EVC-TT-TF-CBL-TYPE2
Nominal Voltage	AC 400V
Nominal Current	32A
Insulation Resistance	$\geq 100M\Omega$
Nominal Power	22KW
Contact Resistance	0.5m Ω
Operating Temperature	(-35°C ~ +50°C)
Mechanical Durability	$\geq 10,000$ Plug Cycles
Protection Class	IP55



TRIO EV CHARGER 22 kW AC ELECTRIC VEHICLE CHARGING UNIT

AC Charging Unit



AC Electric Vehicle Charging Unit

TommaTech Electric Vehicle Chargers (EVC) provide quick and easy charging of electric vehicles with different charging standards through Type II connectors. Offering Economic Mode, Fast Charging Mode, or Custom Mode, these smart and compactly designed chargers are suitable for indoor and outdoor applications. Their wide operating temperature range makes TommaTech EVC chargers a preferred choice for residential, office, and public installations.

Product Features



Emergency Stop Button



100% Compatible with Solar Energy



RFID Card Support



Type 2 cable



IP54 Protection Class



High Efficiency



OCPP 1.6J compatible



100% Domestic Software



Wi-Fi



Suitable for Indoor and Outdoor Use

Connection Diagram

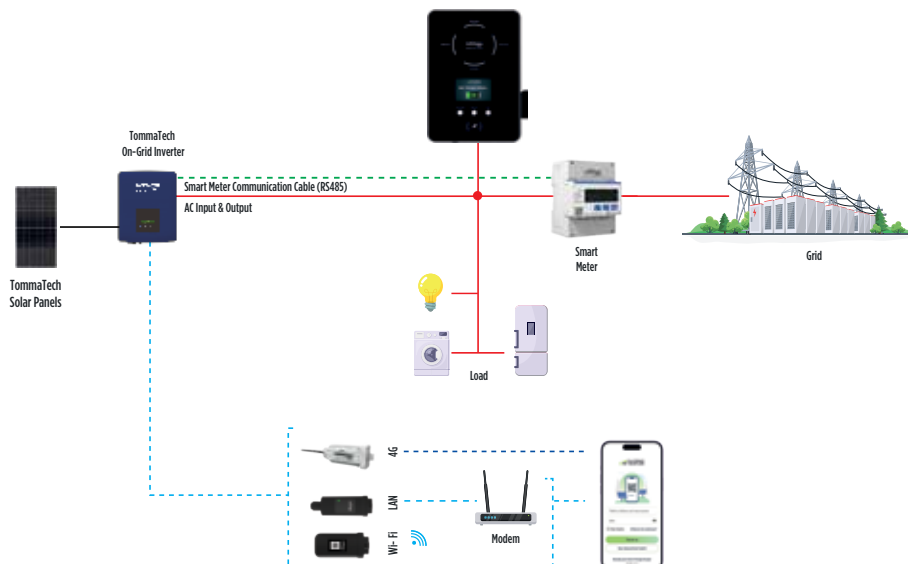

MODEL	Trio-EVC-22.0
AC NOMINAL INPUT	
Phases/Lines	3 Phase / L1+L2+L3+N+PE
Voltage [V]	400±%10
Frequency [Hz]	50/60
AC NOMINAL OUTPUT	
Voltage [V]	400±%10
Current [A]	32
Power [kW]	22
INTERFACE	
Wi-Fi / 4G LTE	Available / Optional
RS485	Yes
RFID	Yes
OCPP 1.6 (JSON)	Optional
LCD Screen	Optional
CT Clamps	Trio Option
GENERAL DATA	
Housing Material	Plastic / Metal
Installation Method	Wall-mounted
Wall Mount Bracket	Yes
Operating Temperature [°C]	-20~+50
Operating Humidity [%]	5%-95% Non-condensing
Operating Altitude [m]	<2000
Protection Class	IP54
Application Area	Indoor / Outdoor
Cooling Concept	Natural Cooling
Dimensions [mm]	249x370x142
Weight [kg]	6.2
SAFETY MEASURES	
Multiple Protections	Over/Under Voltage, Overload, Short Circuit, Leakage Current, Grounding, Surge, Overheat
Leakage Current Protection	30mA Type A RCD (EN 61008) + 6mA DC protection (EN 62955)
Encrypted Communication	TLS
Safety Standards	IEC 61851-1:2017, IEC 62196-2:2016
Integrated PEN Fault Technology	Yes
Warranty [Years]	3

TOMMATECH HIGH-SPEED DC ELECTRIC VEHICLE CHARGING UNIT

30 - 40 KW DC



DC Fast Electric Vehicle Charging Unit

This charging station is built according to the latest industry standards and is compatible with the OCPP protocol. Its robust outdoor design provides strong protection against solid and liquid ingress, ensuring high durability and reliability. Users can conveniently start and stop charging processes via an authorized RFID smart card or mobile application. The unit features a user-friendly interface with a high-contrast screen and multifunction buttons. Additionally, it offers a simultaneous charging capacity of up to 40 kW per outlet with an impressive current rating of 150A.

Product Features



High-Speed Charging



100% Compatible with Solar Energy



Lightning Protection



24/7 Customer Support



IP54 Protection Class



High Efficiency



OCPP 1.6J compatible



Safe Charging Technology



100% Domestic Software



Suitable for Indoor and Outdoor Use

Connection Diagram

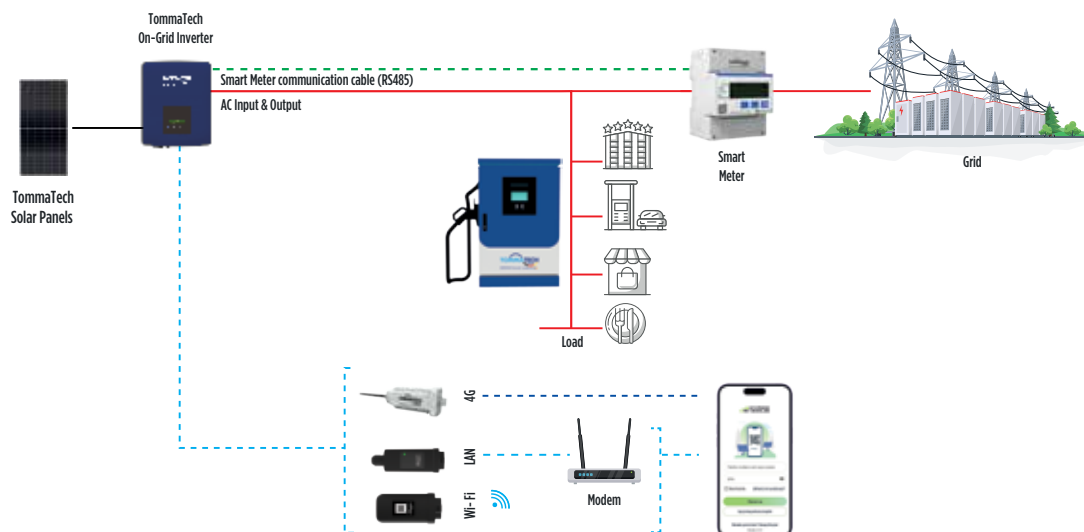

POWER INPUT	30kW	40kW
Input Voltage	400VAC	
Input Current	80A	
Frequency	50Hz	
Power Factor	0,98	
Measurement	Built-in DC Counter	
Efficiency	96% Efficiency	
POWER OUTPUT		
Output Voltage	150-1000VDC	
Output Interface	CCS2 - CCS1 - GBT DC (CCS1 & GBT optional)	
Output Current	100A	150A
PROTECTION		
Built-in AC RCD	30mA	
Built-in DC RCD	DC Isolation 6mA	
Surge Arrester	40kA Type C	
USER INTERFACE		
Languages	Turkish & English	
Status Indicator	Led	
Charging Initiation	RFID, App	
COMMUNICATION		
Network Interface	4G, Wifi, Ethernet	
Protocol	OCPP 1.6J (Upgradable to OCPP 2.1)	
ENVIRONMENTAL FACTORS		
Operating Temperature	-30° to +50°	
Altitude	Up to 2000 m	
MECHANICAL FEATURES		
Protection Class IP (IEC 60529)	IP54	
Protection Pulse IK (IEC 62262)	IK10	
SCREEN	7"	
PHYSICAL PROPERTIES		
Dimensions (D x W x H) [mm]	750 x 300 x 1200	
Weight (kg)	120 kg	120 kg

Product Code	Product Name	Model-No
EVC-TT-DC030KW-100A-1G	TommaTech DC 30KW 100A Single Output EVC	DC030K1G
EVC-TT-DC040KW-150A-1G	TommaTech DC 40KW 150A Single Output EVC	DC040K1G

TOMMATECH HIGH-SPEED DC ELECTRIC VEHICLE CHARGING UNIT

60 - 80 KW DC



DC Fast Electric Vehicle Charging Unit

Manufactured in accordance with the latest industry standards and compliant with the OCPP protocol, this high-speed DC charger is built for outdoor resilience, providing protection against solids and liquids. Users can conveniently initiate or stop charging using an RFID smart card or mobile application. Its high-contrast display and multifunctional buttons offer user-friendly interactions. Furthermore, it enables simultaneous charging with a current capacity of up to 250A, delivering power up to 80 kW per outlet.

Product Features



High-Speed Charging



100% Compatible with Solar Energy



Lightning Protection



24/7 Customer Support



IP54 Protection Class



High Efficiency



OCPP 1.6J compatible



Safe Charging Technology



100% Domestic Software



Suitable for Indoor and Outdoor Use

Connection Diagram

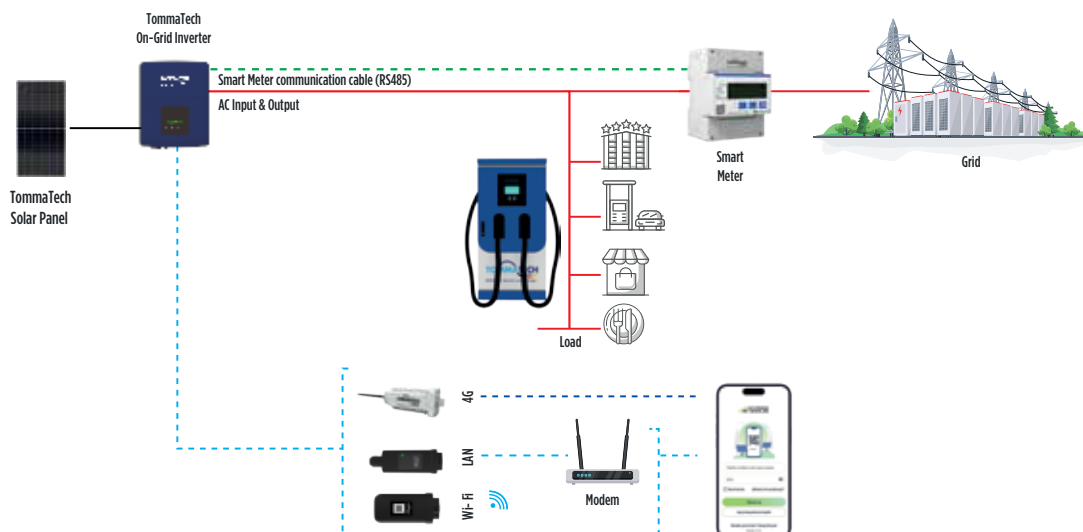

POWER INPUT	60kW	80kW
Input Voltage	400VAC	
Input Current	125A	160A
Frequency	50Hz	
Power Factor	0,98	
Measurement	Internal DC Meter	
Efficiency	96% Efficiency	
POWER OUTPUT		
Output Voltage	150-1000VDC	
Output Interface	CCS2 - CCS1 - GBT DC (CCS1 & GBT optional)	
Output Current	200A	250A
PROTECTION		
Built-in AC RCD	30mA	
Built-in DC RCD	DC Isolation 6mA	
Surge Arrester	40kA Type C	
USER INTERFACE		
Languages	Turkish & English	
Status Indicator	Led	
Charging Initiation	RFID, App	
COMMUNICATION		
Network Interface	4G, Wifi, Ethernet	
Protocol	OCPP 1.6J (Upgradable to OCPP 2.1)	
ENVIRONMENTAL FACTORS		
Operating Temperature	-30° to +50°	
Altitude	Up to 2000 m	
MECHANICAL FEATURES		
Protection Class IP (IEC 60529)	IP54	
Protection Pulse IK (IEC 62262)	IK10	
SCREEN	7"	
PHYSICAL PROPERTIES		
Dimensions (D x W x H) [mm]	750 x 320 x 1550	
Weight (kg)	190 kg	240 kg

Ürün Kodu	Ürün Adı	Model-No
EVC-TT-DC060KW-200A-1G	TommaTech DC 60KW 200A Single Output EVC	DC060K1G
EVC-TT-DC060KW-200A-2G	TommaTech DC 60KW 200A Dual Output EVC	DC060K2G
EVC-TT-DC080KW-250A-2G	TommaTech DC 80KW 250A Dual Output EVC	DC080K2G

TOMMATECH HIGH-SPEED DC ELECTRIC VEHICLE CHARGING UNIT

90 - 120 - 160 - 180 - 240 - 320 - 400 KW DC



DC Fast Electric Vehicle Charging Unit

Designed in accordance with the latest industry standards and fully compliant with the OCPP protocol, this robust outdoor charger provides comprehensive protection against environmental factors, ensuring exceptional durability and reliability. Users can conveniently control charging via RFID smart cards or mobile applications. The charger features an intuitive, user-friendly interface with a high-contrast screen and multifunction buttons. Additionally, with up to 600A current capacity, it can simultaneously deliver power up to 400 kW per charging outlet.

Product Features



High-Speed Charging



100% Compatible with Solar Energy



Lightning Protection



24/7 Customer Support



IP54 Protection Class



High Efficiency



OCPP 1.6J compatible



Safe Charging Technology



100% Domestic Software



Suitable for Indoor and Outdoor Use

Connection Diagram

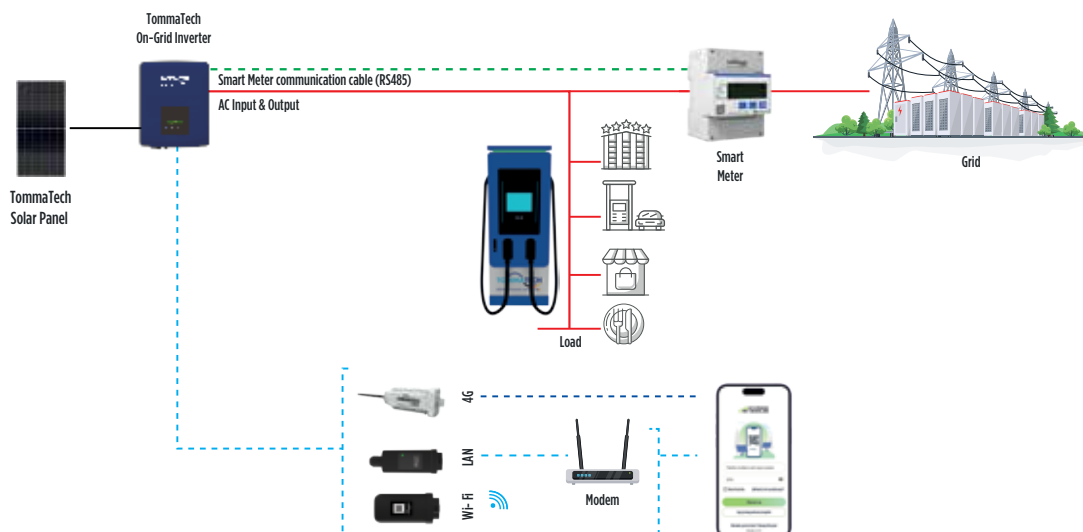

POWER INPUT	90kW	120kW	160kW	180kW	240kW	320kW	400kW
Input Voltage	400VAC						
Input Current	160A	200A	250A	300A	400A	500A	630A
Frequency	50Hz						
Power Factor	0,98						
Measurement	Internal DC Meter						
Efficiency	96% Efficiency						
POWER OUTPUT							
Output Voltage	150-1000VDC						
Output Interface	CCS2 - CCS1 - GBT DC (CCS1 & GBT optional)						
Output Current	300A	400A	500A	500A	500A	600A	600A
PROTECTION							
Built-in AC RCD	30mA						
Built-in DC RCD	DC Isolation 6mA						
Surge Arrester	40kA Type C						
USER INTERFACE							
Languages	Turkish & English						
Status Indicator	Led						
Charging Initiation	RFID, App						
COMMUNICATION							
Network Interface	4G, Wifi, Ethernet						
Protocol	OCPP 1.6J (Upgradable to OCPP 2.1)						
ENVIRONMENTAL FACTORS							
Operating Temperature	-30° to +50°						
Altitude	Up to 2000 m						
MECHANICAL FEATURES							
Protection Class IP (IEC 60529)	IP54						
Protection Pulse IK (IEC 62262)	IK10						
SCREEN	15" (optional 32")						
PHYSICAL PROPERTIES							
Dimensions (D x W x H) [mm]	750x600x2000		750x800x2000		750x900x2000		
Weight (kg)	240 kg	332 kg	362 kg	392 kg	640 kg	670 kg	700 kg

Ürün Kodu	Ürün Adı	Model-No
EVC-TT-DC090KW-300A-1G	TommaTech DC 90KW 300A Single Output EVC	DC090K1G
EVC-TT-DC090KW-300A-2G	TommaTech DC 90KW 300A Double Output EVC	DC090K2G
EVC-TT-DC120KW-400A-2G	TommaTech DC 120KW 400A Double Output EVC	DC120K2G
EVC-TT-DC160KW-500A-2G	TommaTech DC 160KW 500A Double Output EVC	DC160K2G
EVC-TT-DC180KW-500A-2G	TommaTech DC 180KW 500A Double Output EVC	DC180K2G
EVC-TT-DC240KW-500A-2G	TommaTech DC 240KW 500A Double Output EVC	DC240K2G
EVC-TT-DC320KW-600A-2G	TommaTech DC 320KW 600A Double Output EVC	DC320K2G
EVC-TT-DC400KW-600A-2G	TommaTech DC 400KW 600A Double Output EVC	DC400K2G

TOMMATECH 400A BOOSTER HIGH-SPEED DC ELECTRIC VEHICLE CHARGING UNIT

180 KW DC



DC Fast Electric Vehicle Charging Unit

TommaTech's 180 kW High-Speed Charging Units feature advanced 400A Booster technology for rapid charging. With OCPP 1.6J support, these units can additionally provide a profitable revenue stream for your business. The station, equipped with two CCS sockets, offers 400A current per socket for up to 30 minutes, and subsequently 300A, enabling simultaneous rapid charging of two vehicles.

Product Features



High-Speed Charging



100% Compatible with Solar Energy



Lightning Protection



24/7 Customer Support



IP54 Protection Class



High Efficiency



OCPP 1.6J compatible



Safe Charging Technology



100% Domestic Software



Suitable for Indoor and Outdoor Use

Connection Diagram

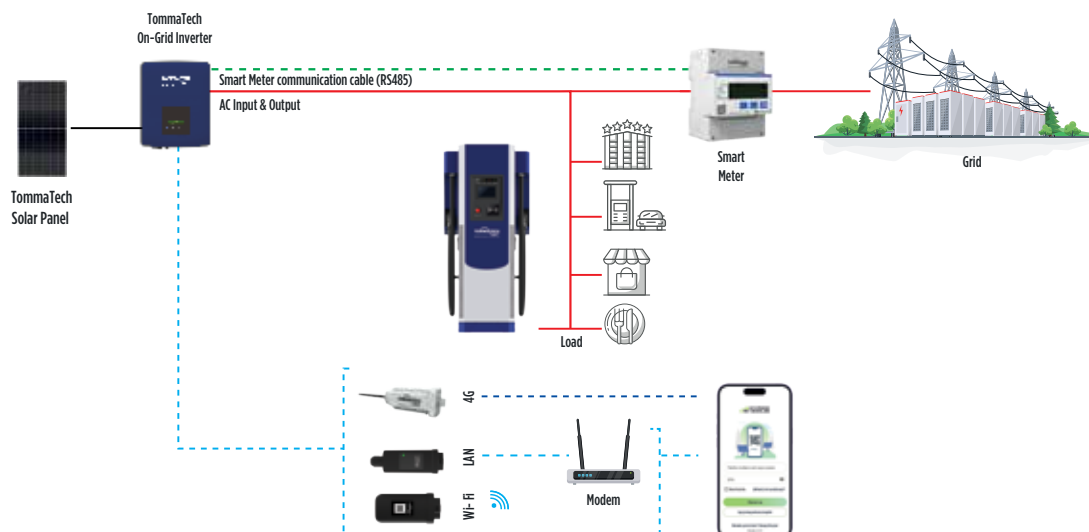

MODEL	180kW
Charging Voltage	DC
Charging Standard	CCS2
Number of Charging Points	2
Input Voltage Range [VAC]	400 / 380 ± 10%
Input Frequency [Hz]	50 / 60
Output Power [kW]	180
DC Output Voltage range [VDC]	200-1000
Cable Length	Standard 5m (optional 6m/7m)
Current [A]	Nominal 300A (400A Booster)
Connector Type	3P + N + PE
Data Transmission via	GSM, 4G, LTE
USER INTERFACE	
Data Access	Internet access via 4G/3G/Ethernet (RJ45)
User Authentication	RFID, QR code
User Interface	7" LCD high contrast touch screen
Communication Protocol	OCPP 1.6
PHYSICAL PROPERTIES	
Protection Class	IP54
Max. Operation Altitude [m]	2000
Operating Temperature [°C]	-35 ~ 55
Storage Temperature [°C]	-40 ~ 70
Dimensions (D x W x H) [mm]	850 x 740 x 1830





PORTAL

experience the
COMFORT OF THE FUTURE



"One Brand, One Application"

Easy Use

With TommaTech Portal, you can easily provide remote monitoring and control of all your devices through a single application. You can make many setting changes and remote monitoring from the voltage and current values you receive from the panels to the occupancy rate of your high voltage battery, from the instantaneous power requirement of your home to the instantaneous consumption of the EV Charger, from the operating mode selection of the hybrid inverter to the water temperature change via the heat pump.

Easy Access

Thanks to various remote monitoring accessories, it offers the option of remote monitoring either wired or wirelessly depending on the installation location.

You can easily log in from anywhere at any time via WEB or APP. By logging in via WEB, you can access the detailed data of your system and create reports on a daily, monthly or annual scale.

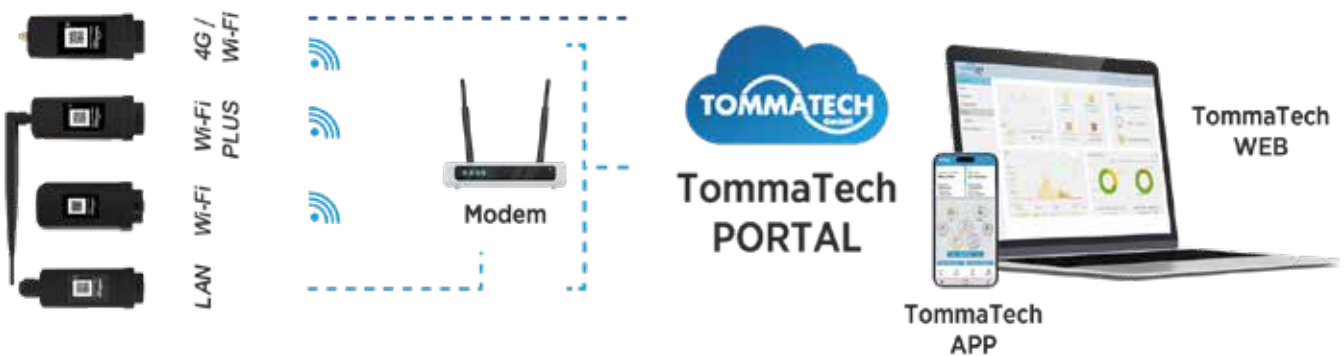

MOBILE AND WEB APPLICATION FEATURES

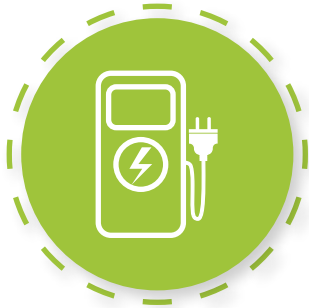

Start / Stop Charging

Securely initiate or terminate charging processes remotely via web or mobile app.



Charging History

View detailed information on all previously completed charging sessions.



Secure Charging Technology

Secure Charging Technology
Enjoy peace of mind with TommaTech's advanced secure charging solutions.



Convenient Payments

Easily perform secure transactions using a variety of payment methods.



Reservation Option

Instantly reserve a charging station via web or mobile application.



Favorite Charging Stations

Designate frequently used CV Charging stations as favorites and benefit from personalized discounts.



CV CHARGING – CHARGE NETWORK OPERATOR SOFTWARE

Become an electric vehicle charging network operator effortlessly with CV Charging Network Operator Software. Our innovative software provides you with either an advantageous leasing model or a direct purchase option, enabling early positioning in the rapidly growing electric vehicle charging sector.

CV Charging Network Operator Software allows you to automatically process customer payments and effortlessly manage payments to your hosting partners. Detailed graphical analytics for daily, monthly, or annual charging sessions are provided for easy monitoring.

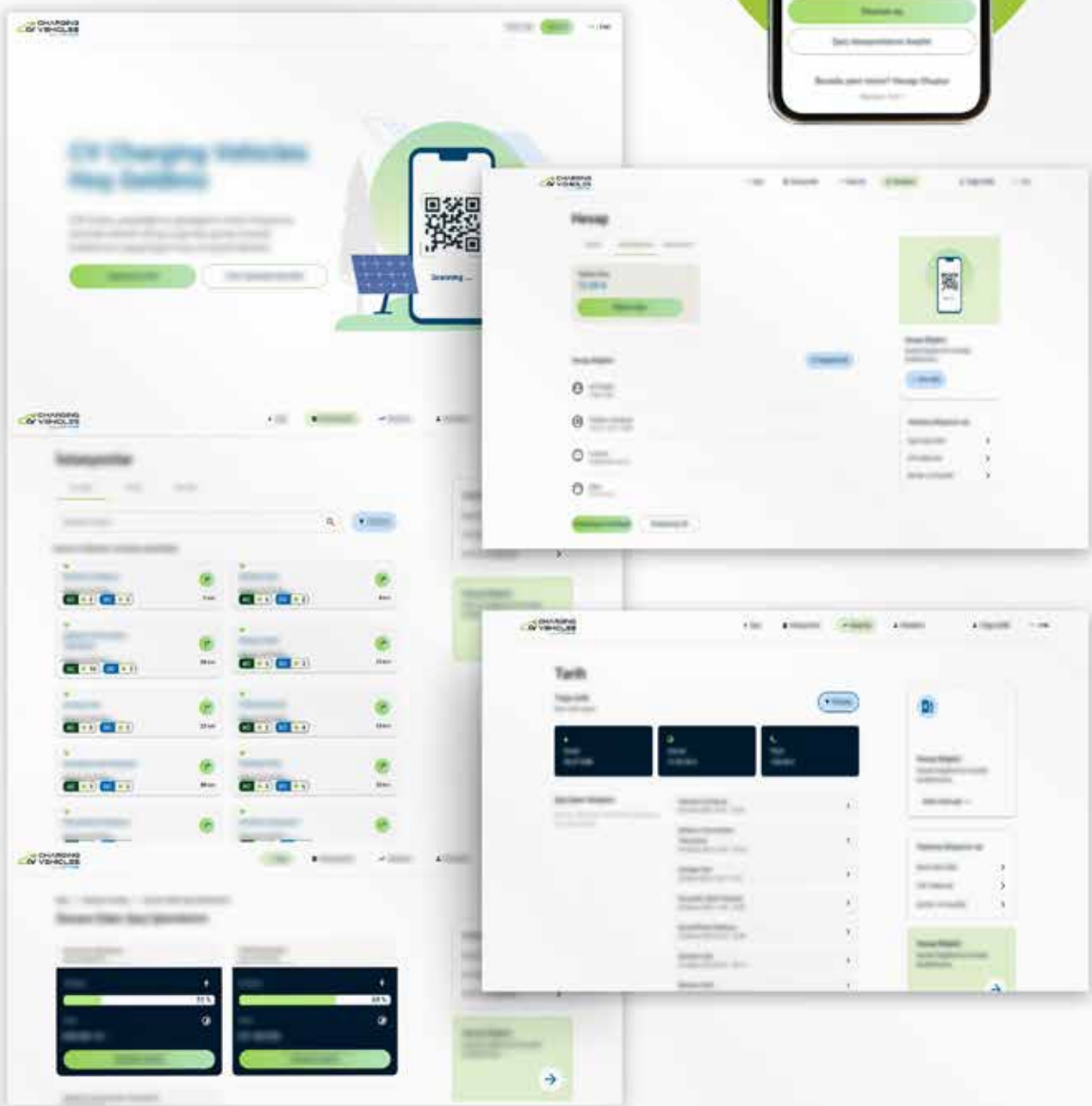



tommatech.de

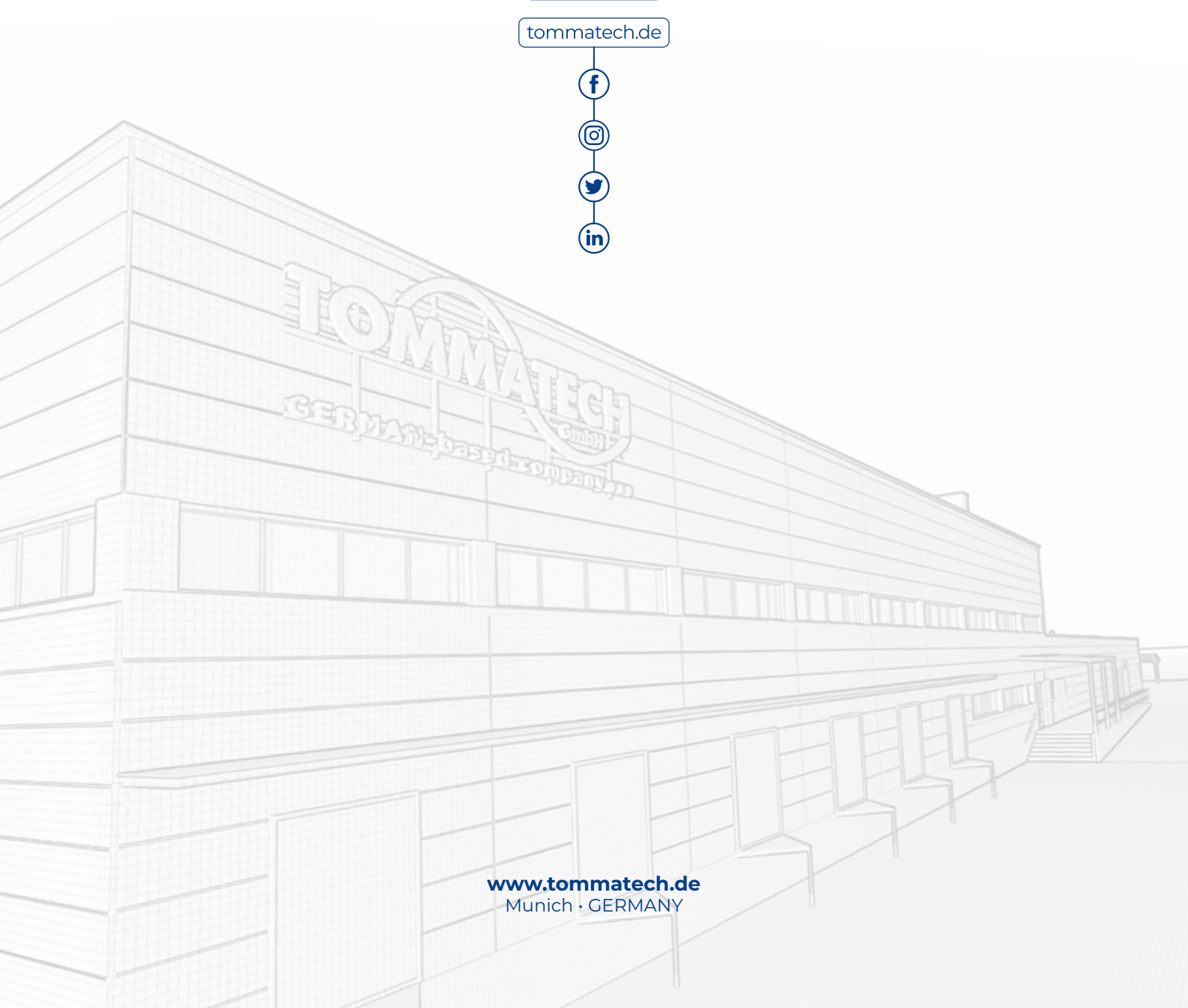

www.tommatech.de
Munich · GERMANY