

EVI DC Inverter Heat Pump (Built-in water pump)

OPERATING INSTRUCTION MANUAL

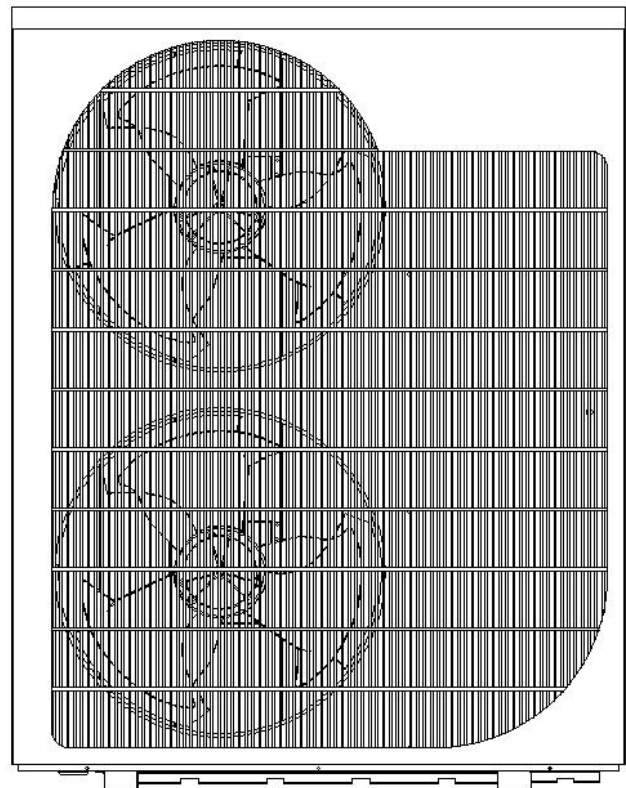
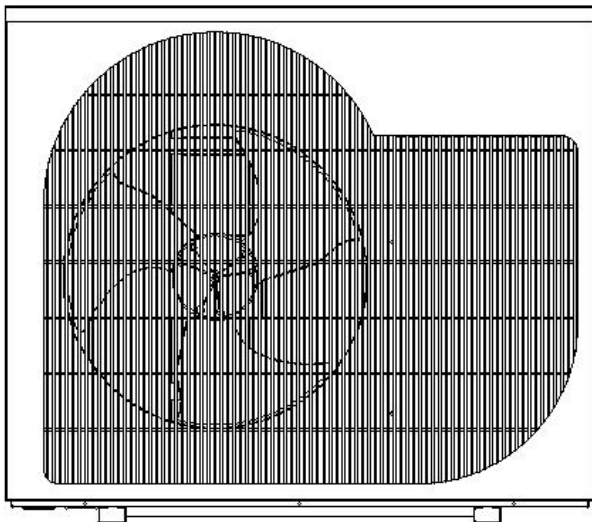

**IMPORTANT SAFETY INSTRUCTIONS
READ AND FOLLOW ALL INSTRUCTIONS
SAVE THESE INSTRUCTIONS**

IMPORTANT SAFETY PRECAUTIONS

Important Notice:

This guide provides installation and operation instructions for the EVI DC Inverter Air Source Heat Pump. Consult the seller with any questions regarding this equipment.

Attention Installer: This guide contains important information about the installation, operation and safe use of this product. This information should be given to the owner and/or operator of this equipment after installation or left on or near the heat pump.

Attention User: This manual contains important information that will help you in operating and maintaining this heat pump. Please retain it for future reference.

 **WARNING** - Before installing this product, read and follow all warning notices and instructions which are included. Failure to follow safety warnings and instructions can result in severe injury, death, or property damage.

Codes and Standards

The EVI DC Inverter Air Source Heat Pump must be installed in accordance with the local building and installation codes as per the utility or authority having jurisdiction. All local codes take precedence over national codes. In the absence of local codes, refer to the latest edition of the National Electric Code (NEC) in the local government Electric Code (CEC) for installation.

DANGER — Risk of electrical shock or electrocution.



The electrical supply to this product must be installed by a licensed or certified electrician in accordance with the National Electrical Code and all applicable local codes and ordinances. Improper installation will create an electrical hazard which could result in death or serious injury to heat pump users, installers, or others due to electrical shock, and may also cause damage to property. Read and follow the specific instructions inside this guide.

 **WARNING** - To reduce the risk of injury, do not permit children to use this product unless they are closely supervised at all times.

Consumer Information and Safety

The EVI DC Inverter Air Source Heat Pumps are designed and manufactured to provide years of safe and reliable service when installed, operated and maintained according to the information in this manual and the installation codes referred to in later sections. Throughout the manual, safety warnings and

cautions are identified by the “” symbol. Be sure to read and comply with all of the warnings and cautions.

Heat Pump Energy Saving Tips

If you do not plan to use hot water for a prolonged period, then you might choose to turn the heat pump off or decrease the temp. setting of the control several degrees to minimize energy consumption.

We offer the following recommendations to help conserve energy and minimize the cost of operating your heat pump without sacrificing comfort.

1. A maximum water temp. of 60°C is recommended.
2. It is recommended to turn off the heat pump when ambient air temp. is less than -30°C or if on vacation for longer than a week.
3. To save energy, it is recommended that the heat pump is operated during daytime when the ambient temp. is higher.
4. Try to install the heat pump at the ventilated places indoor. If it must be installed outdoor, where possible, shelter the heat pump from prevailing winds, rain and snow. Always use a shelter when practical, which will reduce the possibility of frosting and icing.

General Installation Information

1. Installation and service must be performed by a qualified installer or service agent, and must conform to all national, state, and local codes and/or safety regulations.
2. This EVI DC Inverter Air Source Heat Pump is specifically designed for domestic hot water & house heating.

Section 1

Introduction

1.1 Product Overview

EVI DC Inverter Air Source heat pumps transfer heat from the ambient air to water, providing high-temp. hot water up to 60°C. The unique high-temp. heat pump is widely used for house warming. With innovative & advanced technology, the heat pump can operate very well at -30°C ambient temp. with high output temp.s up to 60°C, which ensures the compatibility with normal sized radiator based systems without supplementation. Compared with traditional oil/LPG boilers, EVI DC Inverter heat pump produces up to 50% less CO₂ whilst saves 80% running cost.

Our heat pumps are not only highly efficient, but also easy and safe to operate.

1.2 General Features

1. Low running costs and high efficiency
 - A high coefficient of performance (COP) of up to 5 results in lower running costs compared with traditional ASHP technology.
 - No immersion heater supplement is required.
2. Reduced Capital Costs
 - Simple installation
3. High Comfort Levels

- High storage temp. results in increased hot water availability.
- 4. No potential danger of any inflammable, gas poisoning, explosion, fire, electrical shock which are associated with other heating systems.
- 5. A digital controller is incorporated to maintain the desired water temp..
- 6. Long-life and corrosion resistant composite cabinet stands up to severe climates.
- 7. Panasonic compressor ensures outstanding performance, ultra energy efficiency, durability and quiet operation.
- 8. Self-diagnostic control panel monitors and troubleshoots heat pump operations to ensure safe and reliable operation.
- 9. Intelligent digital controller with friendly user interface and blue LED back light.
- 10. Separate isolated electrical compartment prevents internal corrosion and extends heat pump life.
- 11. The heat pump can operate down to ambient air temp. of -30°C.

Section 2

Installation

The following general information describes how to install the EVI DC Inverter air source heat pump.

Note: Before installing this product, read and follow all warning notices and instructions. Only a qualified service person should install the heat pump.

2.1 Materials Needed for Installation

The following items are needed and are to be supplied by the installer for all heat pump installations:

1. Plumbing fittings.
2. **Level floor for proper drainage**
3. Ensure that a suitable electrical supply line is provided. See the rating plate on the heat pump for electrical specifications. Please take a note of the specified current rating. No junction box is needed at the heat pump; Connections are made inside of the heat pump electrical compartment. Conduit may be attached directly to the heat pump jacket.
4. It is advised to use PVC conduit for the electrical supply line.
5. Use a booster pump for pumping water in case of low water pressure.
6. A filter on the water inlet is needed.
7. The plumbing should be insulated to reduce its heat loss.

Note: We recommend installing shut-off valves on the inlet and outlet water connections for ease of serviceability.

2.2 Technical data

Model	HP-TT-EVI-R32-MF-8.4	HP-TT-EVI-R32-TF-13	HP-TT-EVI-R32-TF-18.2	
Heating Condition - Ambient Temp.(DB/WB): 7/6°C, Water Temp.(In/Out):30/35°C				
Heating Capacity Range (kW)	2.8~8.40	4.40~13.00	5.9~18.2	
Heating Power Input Range(kW)	0.62~1.97	0.95~3.12	1.28~4.26	
COP Range	4.26~4.52	4.17~4.63	4.27~4.61	
DHW Condition-Ambient Temp.(DB/WB): 7/6°C, Water Temp.(In/Out):15/55°C				
Heating Capacity Range (kW)	2.3~6.81	3.52~10.50	4.80~14.72	
Heating Power Input Range(kW)	0.61~2.23	0.93~3.49	1.25~4.75	
COP Range	3.05~3.77	3.01~3.78	3.10~3.84	
Heated water output (L/H)	146	225	315	
Cooling Condition - Ambient Temp.(DB/WB):35/24°C, Water Temp.(In/Out):12/7°C				
Cooling Capacity Range (kW)	2.1~6.22	2.80~8.20	3.81~11.53	
Cooling Power Input Range(kW)	0.67~2.28	0.90~3.41	1.19~4.20	
EER Range	2.73~3.13	2.40~3.11	2.75~3.20	
Power supply	230V/1Ph/50Hz/60Hz	380V/3Ph/50-60Hz		
Max. power input(kW)	3.6	4.5	6.5	
Max. current (A)	16.5	8.5	12.3	
Fuse or circuit breaker (A)	25	16	20	
Wire diameter mm ²	4mm ²	2.5mm ²	4mm ²	
Diameter of pipe (mm)	DN25	DN25	DN25	
Water Flow(m ³ /h)	1.5	2.2	3.2	
Water Pressure Drop (max) kPa	30	35	40	
Net Weight (kg)	105	115	160	
Body size(W*D*H) (mm)	992×488×813	1102×490×964	1075×510×1376	
Packing size(W*D*H)(carton)	1020×510×940	1120×540×1085	1110×540×1500	
Loading quantity (carton)	48/96	48/96	24/48	
Loading quantity (Plywood)	44/88	44/88	22/44	
IP Grade (Level of protection)	IPX4	IPX4	IPX4	
Anti-electric shock Rate	I	I	I	
Refrigerant	R32/1.3kg	R32/1.6kg	R32/2.7kg	
Compressor	Brand	Panasonic	Panasonic	Panasonic
	Model	9RD138ZBA2J	9RD220ZAA2J	9VD420ZAA2J
Water pump	Brand	SHIMGE	SHIMGE	SHIMGE
	Model	APM25-9	APM25-9	APF25-12
Operation Ambient Temp. (°C)	-30~43°C			
Operating water temperature (°C)	28~55°C (DHW)			
Operating water temperature (°C)	15~55°C (Heating)			
Operating water temperature (°C)	7~30°C (Cooling)			

Model	HP-TT-EVI-R32-TF-23	
Heating Condition - Ambient Temp.(DB/WB): 7/6℃, Water Temp.(In/Out):30/35℃		
Heating Capacity Range (kW)	7.5~23.0	
Heating Power Input Range(kW)	1.61~5.38	
COP Range	4.28~4.66	
DHW Condition-Ambient Temp.(DB/WB): 7/6℃, Water Temp.(In/Out):15/55℃		
Heating Capacity Range (kW)	6.1~18.5	
Heating Power Input Range(kW)	1.61~6.12	
COP Range	3.02~3.79	
Heated water output (L/H)	396	
Cooling Condition - Ambient Temp.(DB/WB):35/24℃, Water Temp.(In/Out):12/7℃		
Cooling Capacity Range (kW)	4.73~14.6	
Cooling Power Input Range(kW)	1.47~5.29	
EER Range	2.76~3.22	
Power supply	380V/3Ph/50-60Hz	
Max. power input(kW)	7.35	
Max. current (A)	14	
Fuse or circuit breaker (A)	25	
Wire diameter mm ²	4mm ²	
Diameter of pipe (mm)	DN25	
Water Flow(m ³ /h)	3.9	
Water Pressure Drop (max) kPa	45	
Net Weight (kg)	165	
Body size(W*D*H) (mm)	1075×510×1376	
Packing size(W*D*H)(carton)	1110×540×1500	
Loading quantity (carton)	24/48	
Loading quantity (Plywood)	22/44	
IP Grade (Level of protection)	IPX4	
Anti-electric shock Rate	I	
Refrigerant	R32/2.7kg	
Compressor	Brand	Panasonic
	Model	9VD420ZAA2J
Water pump	Brand	SHIMGE
	Model	APF25-12
Operation Ambient Temp. (℃)	-30~43℃	
Operating water temperature (℃)	28~55℃ (DHW)	
Operating water temperature (℃)	15~55℃ (Heating)	
Operating water temperature (℃)	7~30℃ (Cooling)	

Note:

The above design and specifications are subject to change without prior notice for product improvement.

Detailed specifications of the units please refer to nameplate on the units.

Correct installation is required to ensure safe operation. The requirements for heat pumps include the following:

1. Dimensions for critical connections.
2. Field assembly (if required).
3. Appropriate site location and clearances.
4. Proper electrical wiring.
5. Adequate water flow.

This manual provides the information needed to meet these requirements. Review all application and installation procedures completely before continuing the installation.

2.3 Dimension

HP-TT-EVI-R32-MF-8.4

Unit:mm

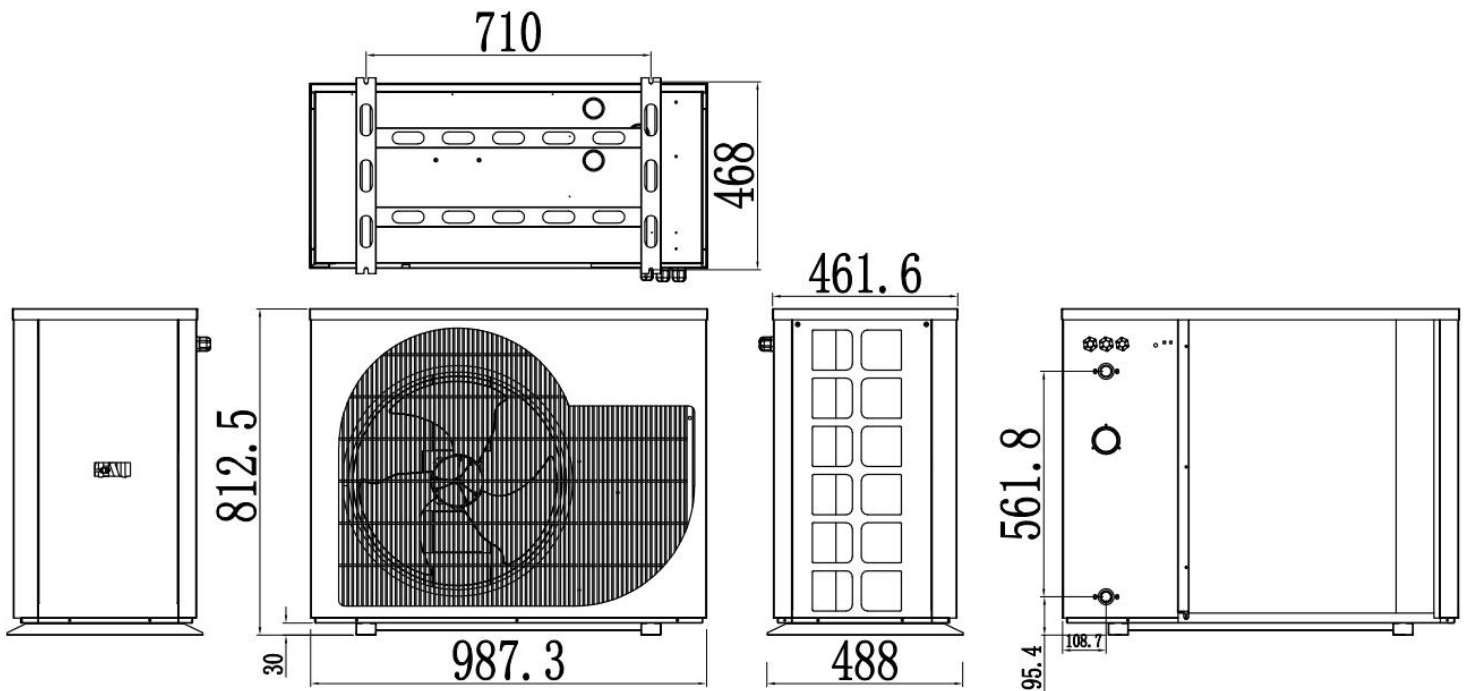

HP-TT-EVI-R32-TF-13

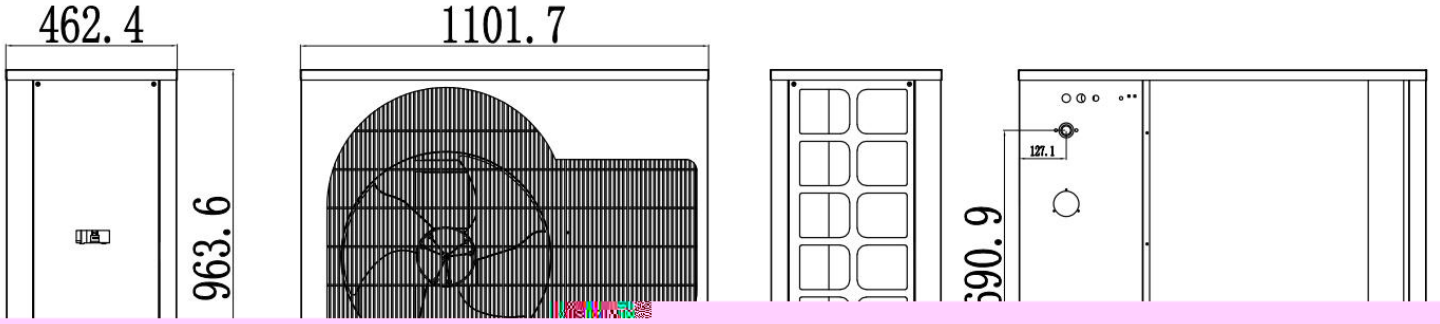
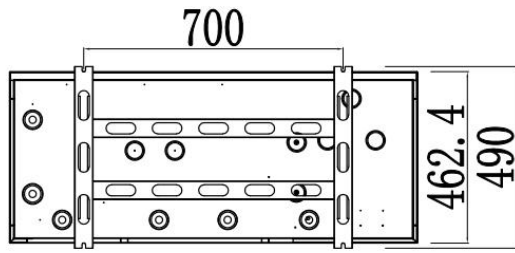

HP-TT-EVI-R32-TF-18.2 HP-TT-EVI-R32-TF-23

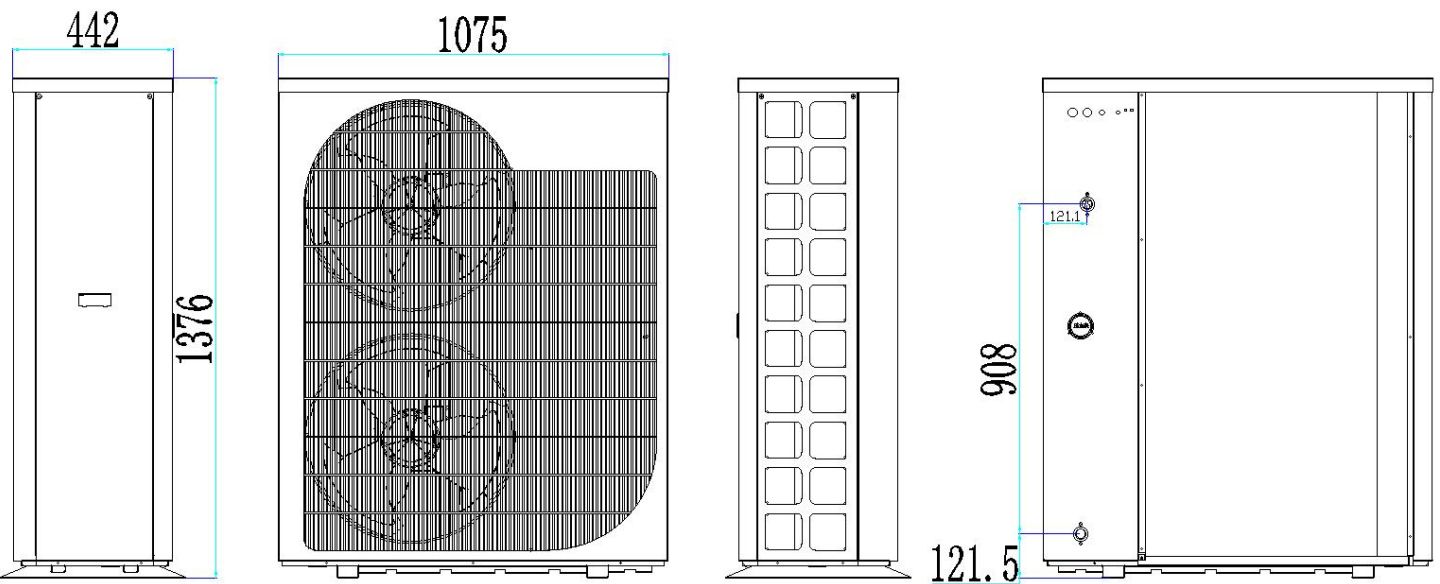
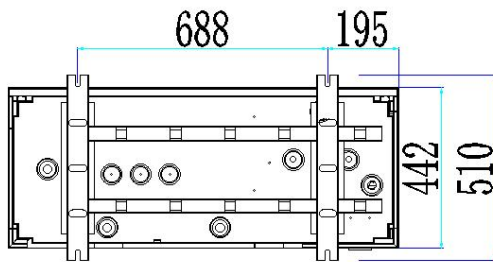

2.4 Exploded view

HP-TT-EVI-R32-MF-8.4

HP-TT-EVI-R32-TF-13

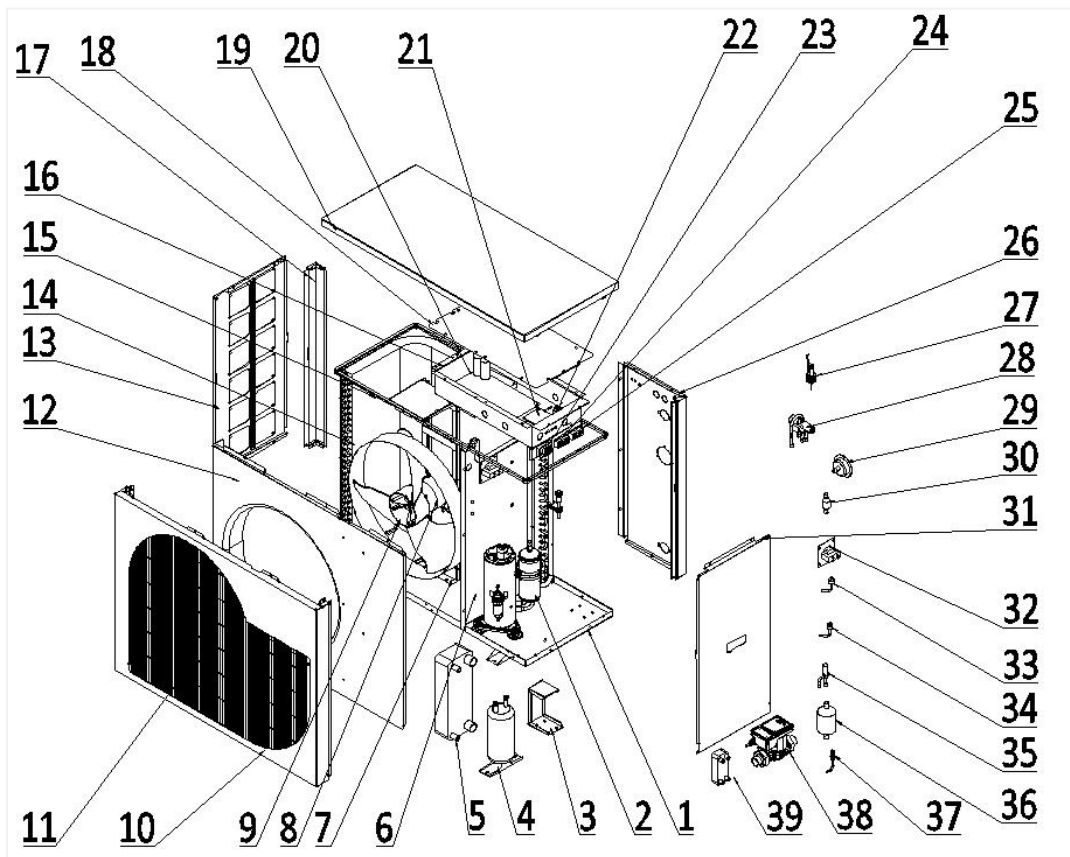

NO	Spare parts	NO	Spare parts
1	chassis	21	mainboard
2	compressor	22	Terminal block
3	water pump bracket	23	Terminal block
4	liquid storage tank	24	Terminal block
5	plate heat exchanger	25	Terminal block
6	center spacer	26	rear side panel
7	motor bracket	27	water flow switch
8	motor	28	4-way valve
9	fan blade	29	pressure gauge
10	front panel	30	drying filter
11	front protective net	31	right side panel
12	wind guide ring	32	electric reactor
13	left side panel	33	high pressure switch
14	fin heat exchanger	34	low pressure switch
15	top frame	35	electronic expansion valve
16	electric box	36	filter
17	back net	37	Needle valve
18	electric box cover	38	water pump
19	top panel	39	plate heat exchanger
20	driver board		

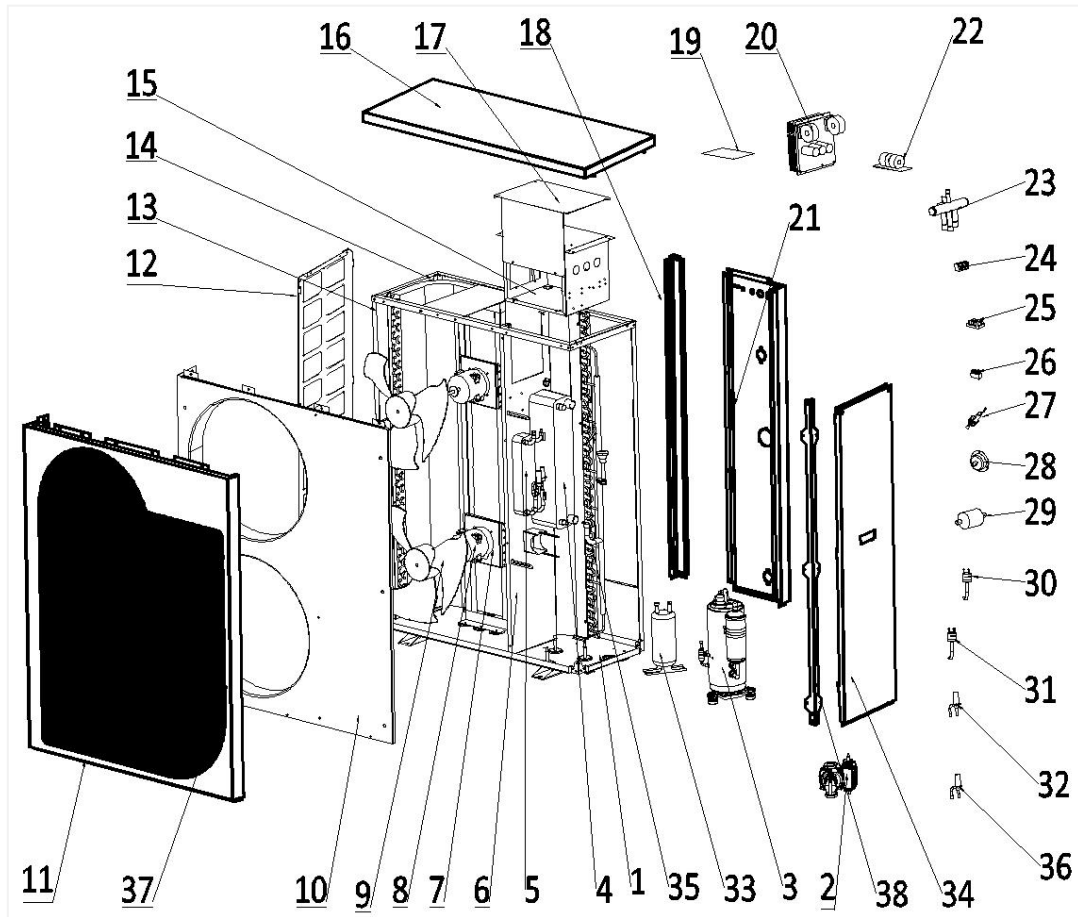

NO	Spare parts	NO	Spare parts
1	chassis	21	rear side panel
2	water pump	22	electric reactor
3	compressor	23	4-way valve
4	plate heat exchanger	24	terminal block
5	plate heat exchanger	25	terminal block
6	center spacer	26	terminal block
7	motor bracket	27	water flow switch
8	motor	28	pressure gauge
9	fan blade	29	drying filter
10	deflector	30	high pressure switch
11	front panel	31	low pressure switch
12	left net	32	electronic expansion valve
13	column	33	liquid storage tank
14	top frame	34	right side panel
15	electric box	35	fin heat exchanger
16	top panel	36	electronic expansion valve
17	electric box cover	37	fan protection net
18	back net	38	stand columns
19	mainboard		
20	driver board		

Installation Location



CAUTION!

1. DO NOT install the heat pump near to hazardous materials and places
2. DO NOT install the heat pump under deep sloping roofs without gutters which will allow rain water, mixed with debris, to be forced through the unit.
3. Place the heat pump on a flat slightly pitched surface, such as concrete or fabricated slab. This will allow proper drainage of condensation and rain water from the base of the unit. If possible, the slab should be placed at the same level or slightly higher than the filter system/equipment.

2.5 Installation Details

All criteria given in the following sections reflect minimum clearances. However, each installation must also be evaluated, taking into account the prevailing local conditions such as proximity and height of walls, and proximity to public access areas. The heat pump must be placed to provide clearances on all sides for maintenance and inspection.

1. The heat pump installation area must have good ventilation and the air inlet/outlet must not be hindered.
2. The installation area must have good drainage and be built on a solid foundation.
3. Do not install the unit in areas accumulated with pollutions like aggressive gas (chlorine or acidic), dust, sand and leaves etc.
4. For easier and better maintenance and troubleshooting, no obstacles around the unit should be closer than 1m. And no obstructions within 2m, vertically, from the unit for air ventilation. (See Figure 1)

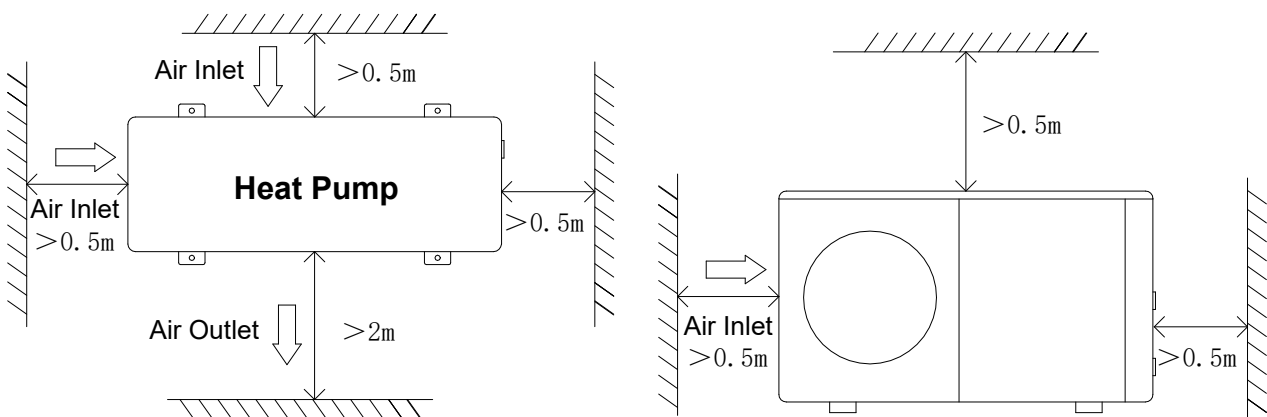

Figure 1

- The heat pump must be installed with **rubber vibration damper** to prevent vibration and/or imbalance. (See Figure 2)

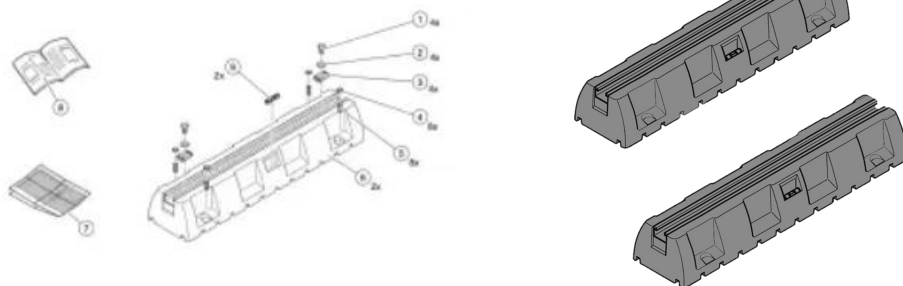

Figure 2

- Even though the controller is waterproof, care should be taken to avoid direct sunlight and high temp.. In addition, the heat pump should be placed to ensure quality viewing of the controller.
- The plumbing pipes must be installed with proper support to prevent possible damage due to vibration. Running water pressure should be kept over 196kpa. Otherwise, booster pump should be installed.
- The acceptable operating voltage range should be within $\pm 10\%$ of the rated voltage.
 - The heat pump unit must be grounded /earthed for safety purposes.

2.6 Drainage and Condensation

Condensation will occur from the evaporator when the unit is running at heating mode and drain at a steady rate, depending upon ambient air temp. and humidity. The more humid the ambient conditions, the more condensation will occur. The bottom of the unit acts as a tray to catch rainwater and condensation. Keep the drain holes, located on the bottom pan of the unit base, clear from debris at all times.

2.7 Suggested Installation Methods

DC Inverter Heat Pump can provide heating/cooling and domestic hot water. Floor heating loops and Radiator are used for space heating and fan coil units are used for space cooling. Domestic hot water is supplied from the domestic hot water tank connected to the heat pump.

DC Inverter Heat Pump with a main circulation pump built inside. When install the unit, installers should connect the heat pump with other parts including the buffer tank (for space heating/cooling), storage water tank (for domestic hot water). External fittings are also needed including a safety valve, a water charge valve, Three-way valve. Temperature sensor should be added in the storage water tank. An additional electric heater can be installed in the DHW tank or the buffer tank which can get the control signal from the heat pump.

- 1) System installation diagram to see Figure 3, Figure 4.**
- 2) 3-way valve: For domestic hot water mode, 3-way valve powers on. For underfloor heating or cooling, 3-way valve powers off.**
- 3) When both heating (or cooling) and domestic hot water don't reach the setting temp., hot water is priority.**
- 4) The hot water tank with coil for domestic hot water should be specially customized.**
- 5) The heat exchange capacity of the coil should be \geq the rated heating capacity of the heat pump.**
- 6) The unit is delivered ready for operation and is filled with R32 refrigerant.**
- 7) The refrigerant R32 are flammable and explosive, It's prohibited from installing in one environment which have operating or potential ignition sources.**

Schematic diagram of secondary cycle installation

Figure 3

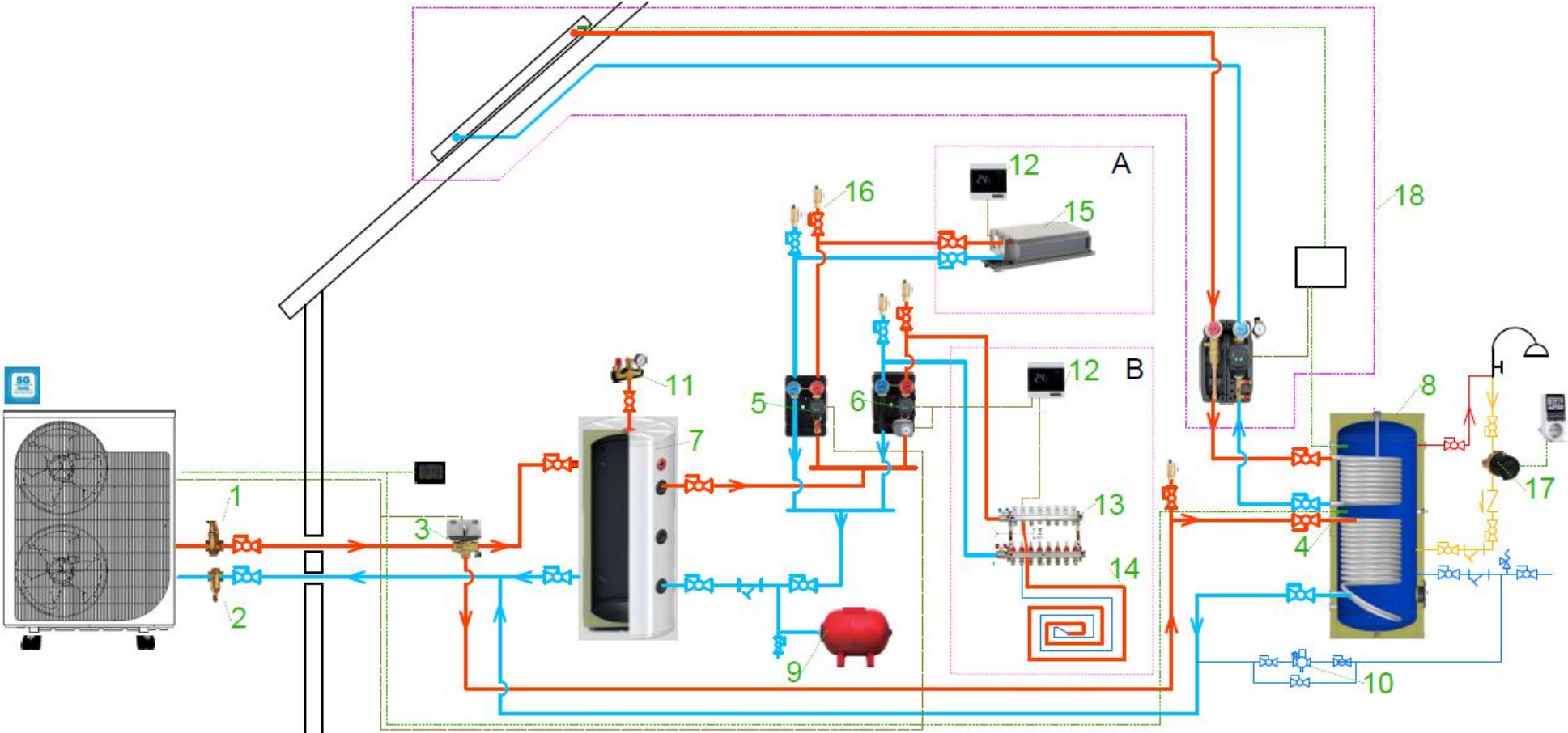

1	Air purger
2	Magnetic partical seperator
3	3 Way valve
4	Hot water tank temp. sensore
5	Pump group (for fan-coils)
6	Pump group (for underfloor heating)
7	Buffer tank
8	Domestic hot water tank
9	Closed expansion tank
10	Automatic filling valve
11	Safety valve, air purger and manometer group
12	Room thermostat / Heating-Cooling
13	Floorheating coolector with actuator and flow adjusted
14	Floorheating pipe
15	Fan-Coil unit for cooling
16	Air purger
17	Hot water re-circulation pump
18	Solar thermal water heating control system

Figure 4

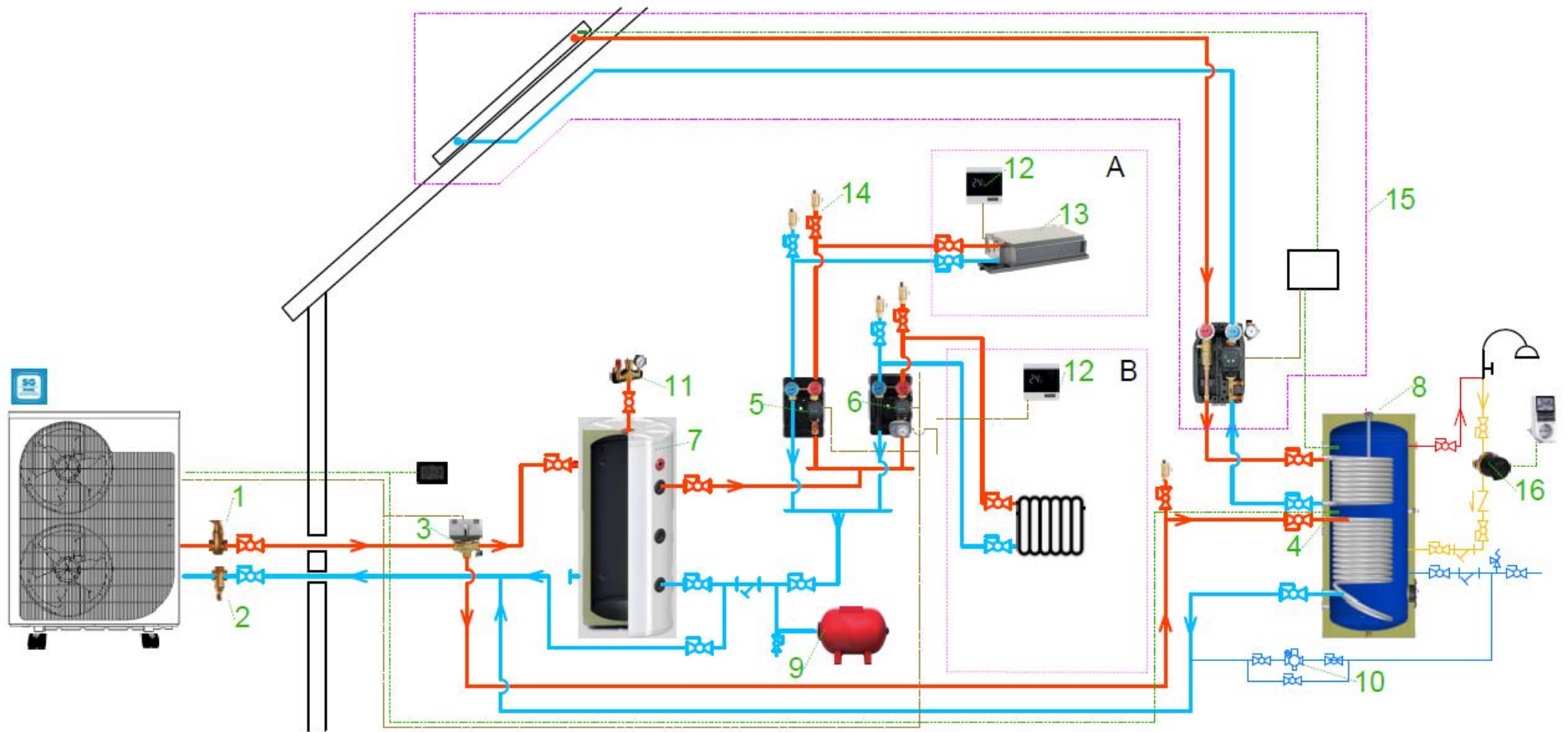

1	Air purger
2	Magnetic partikul seperator
3	3 Way valve
4	Hot water tank temp. sensore
5	Pump group (for fan-coils)
6	Pump group (for underfloor heating)
7	Buffer tank
8	Domestic hot water tank
9	Closed expansion tank
10	Automatic filling valve
11	Safety valve, air purger and manometer group
12	Room thermostat / Heating-Cooling
13	Fan-Coil unit for cooling
14	Air purger
15	Solar thermal water heating control system
16	Hot water re-circulation pump

2.8 Water Connections

Water Connections at the Heat Pump

Quick Connect fittings are recommended to be installed on the water inlet and outlet connections. It is recommended to use stainless steel or PPR pipes for the heat pump plumbing. The water inlet and outlet connection to the heat pump accepts stainless steel or PPR pipe fittings.



CAUTION — Make sure that flow requirements and tap water turnover rates can be maintained with the installation of additional heat pumps and plumbing restrictions.

Plumbing Installation Requirements

1. Be sure to comply with the minimum diameters that should be used according to the capacities of heat pumps. See **Table 1**.

Minimum pprc diameters that must be used according to the capacities of heat pumps						
HP Model.	Capacity kW	Pipe Connect. Diam.	Inner diam mm	PPRC	Outer diam. mm	Inner diam mm
HP-TT-EVI-R32-MF-8.4	8,4	DN25	26,9	32	20	13,8
HP-TT-EVI-R32-TF-13	13	DN25	26,9	32	25	16,6
HP-TT-EVI-R32-TF-18.2	18,2	DN25	26,9	40	32	22
HP-TT-EVI-R32-TF-23	23	DN25	26,9	40	40	27

Table 1

Please check, compensation outer and inner diameter of DN and pprc pipe in **Table 2**

2. Flush the old plumbing before installing and connecting the heat pump.
3. Flush the new installation without connecting the heat pump.
4. When the water pressure exceeds 3 bar, please use reducing valve to reduce the water pressure below 2,5 bar.
5. Each part connected to unit needs to be connected with method of loose joint and installed with intermediate valve.
6. Ensure that all plumbing has been properly completed and then proceed to do a water leakage and pressure test.
7. All the pipelines and pipe fittings must be insulated to prevent heat loss.

8. Install a drain valve at the lowest point of the system to enable the system to be drained during freezing conditions (winterizing).
9. Install a check valve on the water outlet connection in order to prevent back siphoning when water pump stops.
10. In order to reduce the back pressure, the pipes should be installed horizontally
11. And minimize number of the elbows (90 degrees connections).for prevent more pressure loses.
12. The hardness of the water filled into the installation must be 10 German hardness.
13. At least 15% of the filled water amount should be filled with a chemical that protects against calcification, corrosion and freezing.
14. Pipe installation must be properly thermally insulated with rubber thermal insulation material.

Compensation outer and inner diameter of DN and pprc pipe						
DN diam.	Inch	Outer diam. mm	Inner diam mm	PPRC	Outer diam. mm	Inner diam mm
DN10	3/8"	17,2	12,6	20	20	13,8
DN15	1/2"	21,3	15,7	25	25	16,6
DN20	3/4"	26,9	21,1	32	32	22
DN25	1"	33,7	26,9	40	40	27
DN32	1 1/4"	42,4	35	50	50	34,5
DN40	1 1/2"	48,3	40,9	63	63	42
DN50	2"	60,3	52,5	75	75	51
DN65	2 1/2"	76,1	62,6	90	90	63

Table 2

2.9 Electrical Connections



WARNING —Risk of electrical shock or electrocution.



Ensure that all high voltage circuits are disconnected before commencing heat pump installation. Contact with these circuits could result in death or serious injury to users, installers or others, due to electrical shock and may also cause damage to property.



CAUTION — Label all wires prior to disconnection when servicing the heat pump. Wiring errors can cause improper and dangerous operation. Check and ensure proper operation after servicing.

2.9.1 Power Supply

1. If the supply voltage is too low or too high, it can cause damage and/or result in unstable operation of the heat pump unit, due to high inrush currents on start up.
2. The minimum starting voltage should be above 90% of rated voltage. The acceptable operating voltage range should be within $\pm 10\%$ of the rated voltage.
3. Ensure the cable specifications meet the correct requirements for the specific installation. The distance between the installation site and mains power supply will affect the cable thickness. Follow the local electrical standards to select the cables, circuit breakers and isolator breakers.

2.9.2 Grounding and Over Current Protection

In order to prevent electrical shock in case of leakage from unit, install the heat pump according to local electrical standard.

1. Do not interrupt the voltage supply to the heat pump frequently as this may result a shorter life expectancy of the heat pump.
2. When installing over current protection, ensure that the correct current rating is met for this specific installation.
3. If an additional auxiliary heater is need to be controlled by the heat pump controller, the relay (or power) of the aux-heater must be connected to the relevant output of the controller.

Electrical connections

Mains connection:

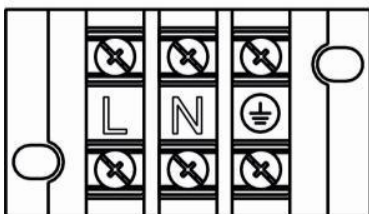

Version 1~ 230V/50Hz

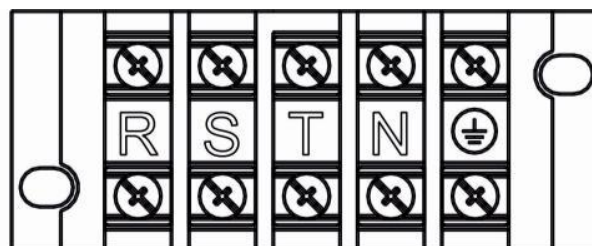

3~ 400V/50Hz version

The heat pump is ready to be connected to the mains 230V/1~50Hz or 400V/3~50Hz on the terminals shown in the diagram (see wiring diagram), go inside the device, open the cover of the device and enter the electrical terminal area and locate the power terminals. Be sure to connect

ground and ground. The size and type of power cables must always comply with applicable regulations. Nevertheless, in the table containing the parameters of the device, you can find the recommended minimum cross-sections of connecting cables.

In order to correctly select the type and size of the main power cord of the device, the electricity consumption of optional accessories connected to the heat pump (auxiliary electric heater, circulation pump, solenoid valves, etc.) is also included. The table shows the maximum consumption for the combination of heat pump and auxiliary electric heater.

The electrical connection of the heat pump must be protected by a quick-acting residual current device in accordance with the regulations and technical conditions in force at the place of installation.

Important: Before carrying out any work on the heat pump's electrical system, always make sure that it is disconnected from the mains.

2.9.3 Connecting the auxiliary electric heater

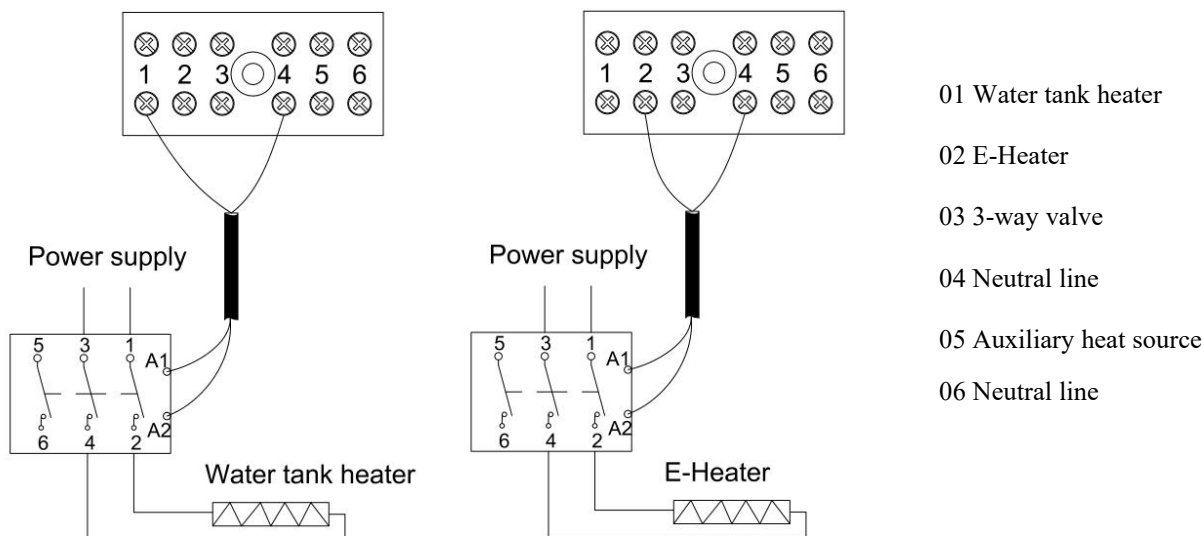

Diagram of connecting an additional heater

The supplied Heat Expert series heat pump, as a device intended for operation in a moderate and cold climate, does not have a built-in additional electric heater that can be used as an additional source of heat energy and in most cases its use is not required. Nevertheless, if it is necessary to use electric systems of heaters supporting the operation of the heat pump, the manufacturer provides for the possibility of their cooperation with the supplied heat pump. For this purpose, the Heat Expert pump has a built-in system that controls the operation of an additional electric heater,

which provides a control signal to the contactor that switches on and off the electric heater properly selected for the heating system. Parameters of the signal controlling the operation of the additional electric heater: ~230V/50Hz max 2A.

Note: Do not connect additional heaters directly to the heat pump's control terminals!

2.9.4 Cascading wiring

When using the cascade function, it is necessary to set the correct number of units in cascade mode on the heat pump's main board via Switch 1-4. It is possible to control the operation of up to 8 units, connecting the cascade is done using the CN3 or CN6 connector of the main board.

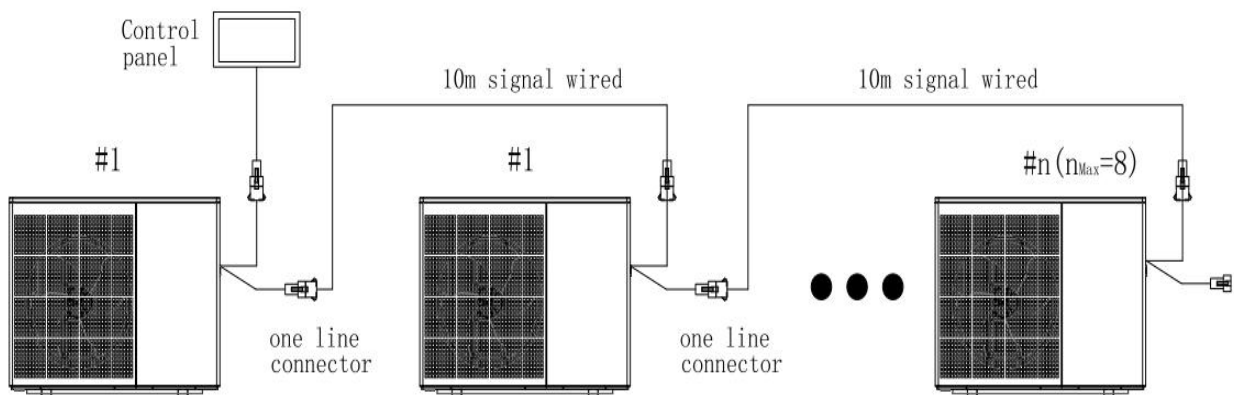

Principles of addressing devices working in a cascade system

Device number	SW1-2	SW1-3	SW1-4
1#	OFF	OFF	OFF
2#	OFF	OFF	ON
3#	OFF	ON	OFF
4#	OFF	ON	ON
5#	ON	OFF	OFF
6#	ON	OFF	ON
7#	ON	ON	OFF
8#	ON	ON	ON







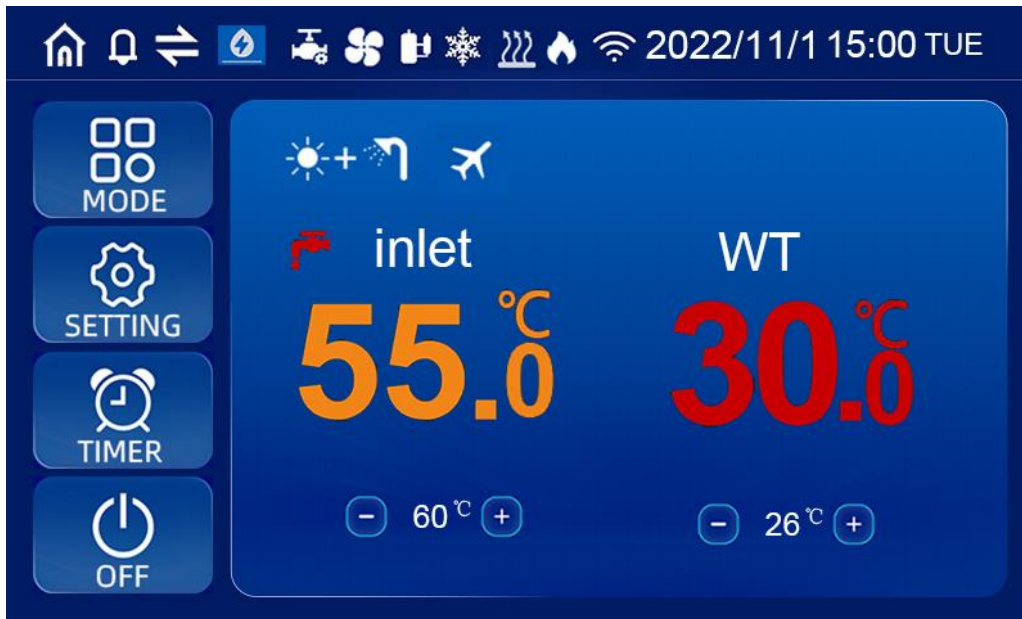









Section 3

Operating Heat Pump













Controller Panel

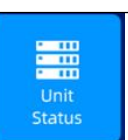
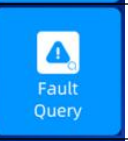

3.1 Display Icon

Mode	Meaning	Mode	Meaning
	Heating mode		Compressor working
	Hot water mode		Water pump working
	Cooling mode		Fan motor working
	Heating and Hot water Mode (Hot water function as priority)		Water tank heater working
	Cooling and Hot water Mode (Hot water function as priority)		Electric heating working
	Smart mode		Defrosting
	Power mode		Anti-freezing
	Silent mode		Auxiliary heat source
	Vacation mode		

3.2 Definition of Buttons

Button	Description	Function
	On/off	turn on or turn off the heat pump.
	Mode	switch the operating mode of the heat pump.
	Timer	set timer switch and working weekdays.
	Setting	query running parameters, check and set system parameters, error code records, Wifi connection, etc.
	Temperature setting 1	Temperature setting for only hot water, only heating and only cooling mode (the interface displays the inlet water temperature and outlet water temperature)
	Temperature setting 2	In hot water+heating or hot water+cooling mode , the left side is temperature setting for heating and cooling, and the right side is temperature setting for hot water (the main interface temperature display shows on the left side is inlet water temperature, and on the right side is water tank temperature)
	Status	Check the running parameters of the heat pump
	Faulty	Record the most recent error codes
	Wifi	Wifi setting
	User parameters	Check and set the user parameters of the heat pump
	Factory parameters	Check and set the factory parameters(Do not advise to amend the factory parameters.
	Run the curve	Check the inlet water and outlet water operation curves and operation power curves.
	System parameters	Check the version information of the system motherboard and the remote control program.

 Language	Language	Language selection
---	----------	--------------------

3.3 Wire Controller Operation

3.3.1 Start / Stop The Heat Pump

©In the main interface, press the "ON/OFF" key for 1 second, and the "Startup Confirmation" pop-up window pops up. After the startup is confirmed, the mode symbol is displayed in the startup status, but not in the shutdown status.



3.3.2 Set Target Water Temperature

In single mode (only cooling, only heating, only hot water mode), click "+" and "-" on the main interface to adjust the required temperature; in dual mode (heating+hot water, cooling+hot water mode), click "+" and "-" on the left side of the main interface to adjust the required heating and cooling temperature; click "+" and "-" on the right side to adjust the required hot water temperature.



3.3.3 Running Mode Setting/Operating Mode Selection

In the main interface, press the "MODE" key for 1 second to enter the operation mode, frequency mode and holiday mode selection interface, and select the required operation mode (parameter setting model) and frequency mode of the unit;

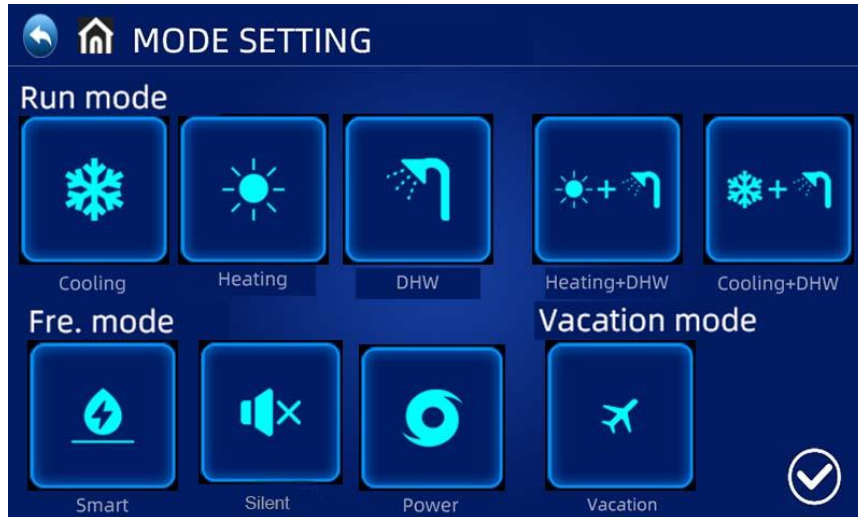

◎Click“ MODE”on the Setting interface to enter Operating mode selection interface;

◎Operating mode description : In the normal mode, Heat pump has Smart,Powerful,& Silent Operating states to choose.

◎Vacation mode description: When this mode is enabled,The heat pump runs in heating mode only,with a Target temperature of vacation Set;

3.3.4 Clock Setting

◎In the main interface, press **2022/11/1 15:00 TUE** to enter clock setting interface as below.

◎Press the date (Year/Month/Day column) or hour (Hour:Minute column) , the keyboard will occur to input the value. Press the weekday(Weekday column) to switch from Mon. to Sun.

◎Press CONFIRM button to save and exit, or press CANCEL button to exit without saving.

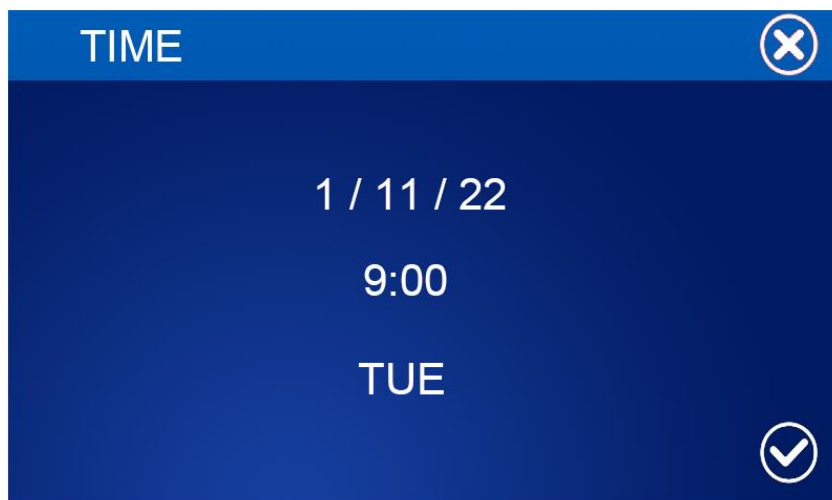

3.3.5 TIMER SETTING

- ⦿ In the main interface, press TIMER button to enter timing setting interface.
- ⦿ In the WEEK column, users can select which weekdays to perform timer switch. When the weekday button (From MON. to SUN.) turns highlight white, the timer will perform on that day. When the weekday button turns gray, the timer will not perform on that day.
- ⦿ In the TIMER column, users can set 4 pairs of timer at maximum
- ⦿ The timer is invalid when the turn on time equals the turn off time in the same timer.



SILENT TIME:



- ⦿ Click “” in the “SET TIME” Interface to enter Timing silent interface, The unit will runs as Silent Mode during the scheduled mute time.

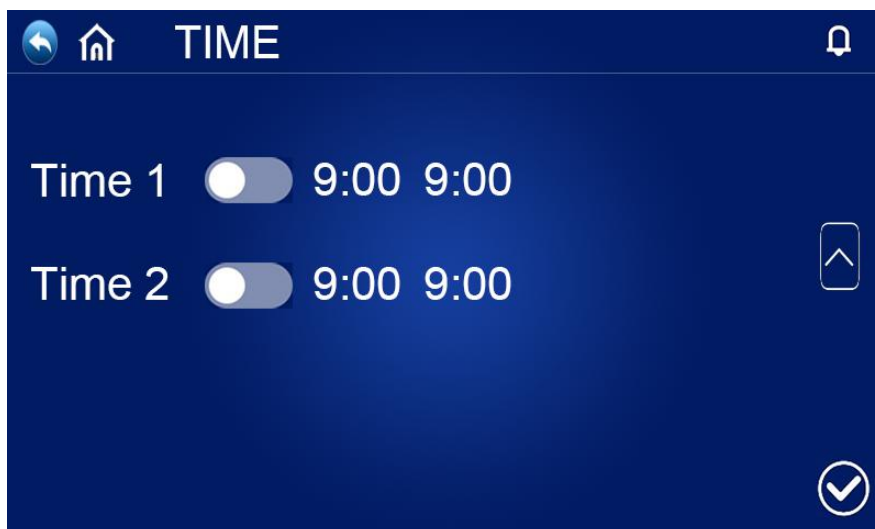

3.3.6 Operation Parameter Query

Press the "SETTING" key in the main interface to enter the setting interface. Then press "UNIT STATUS" to enter the unit list interface, select the corresponding unit to enter the "Parameter Query", and check the operation status of the heat pump. The status table is as follows:

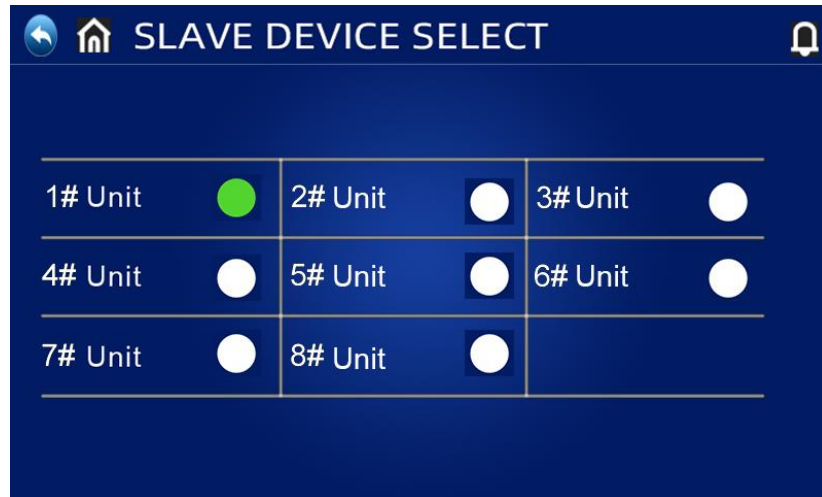

Forced defrosting: In the unit selection interface of the query status, press and hold the corresponding unit number to pop up the forced defrosting selection interface of the corresponding unit. If Yes is selected, the corresponding unit enters forced defrosting.

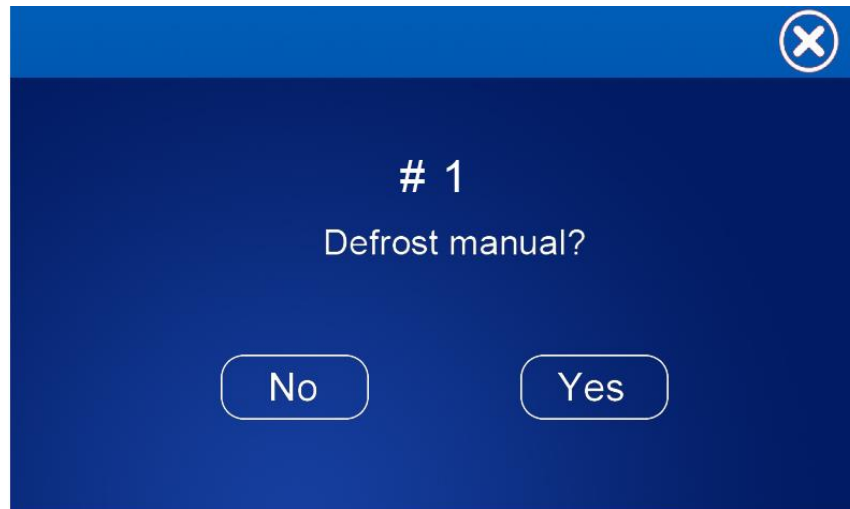



©List of operation parameters

Code	Description	Remark
01	Water inlet temp.	-30~99℃
02	Water outlet temp.	-30~99℃
03	Ambient temp.	-30~99℃
04	Exhaust gas temp.	0~125℃
05	Return gas temp.	-30~99℃
06	Evaporator coil temp.	-30~99℃

07	Inlet temp. of economizer	-30~99℃
08	Outlet temp. of economizer	-30~99℃
09	Cooling coil temp.	-30~99℃
10	Water tank temp.	-30~99℃
11	Opening of main expansion valve	
12	Opening of assistant expansion valve	
13	Compressor current	
14	Heat sink temp.	
15	Compress target frequency	
16	Compress actual frequency	
17	Low pressure gauge pressure value (R290)	Real time data(Bar)
18	Low pressure conversion temp.	
19	Wind speed of DC fan 1	
20	Wind speed of DC fan 2	
21	EUV powered signal	
22	SG grid signals	
24	DC bus voltage value	
25	Heating Capacity	
26	Current water flow Volume	
27	Current of the entire machine	
28	Voltage	
29	Power Rate	
30	COP(EER)	
31	Target rotation speed of DC water pump	
32	DC pump speed	
33	Emergency switch	
34	Linkage switch	
35	Water flow switch	
36	Low pressure switch	
37	High pressure switch	
38	Heat pump billing costs	
39	Gas billing costs	

3.3.7 Check Energy Consumption Curve

Press the "SETTING" key in the main interface to enter the setting interface. Then click "Run the curve" to enter the energy consumption curve interface, click  and  at the bottom of the interface to switch "temperature curve", "operating power curve" and "COP curve"., "heating capacity", "daily power consumption curve", "monthly power consumption curve", "annual power consumption curve".

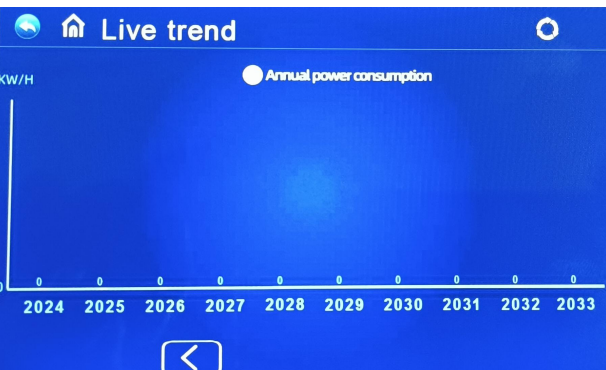
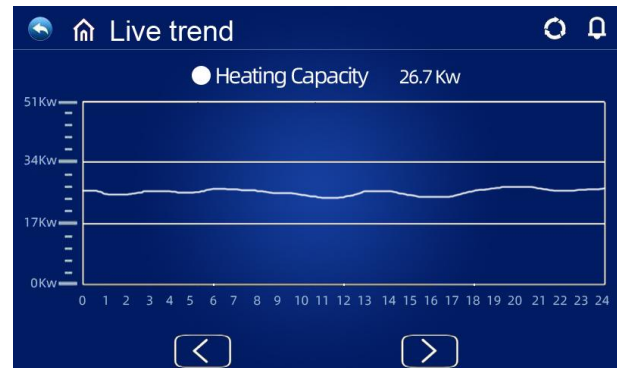
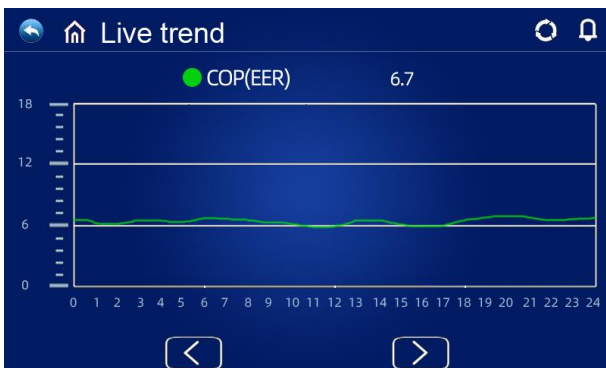
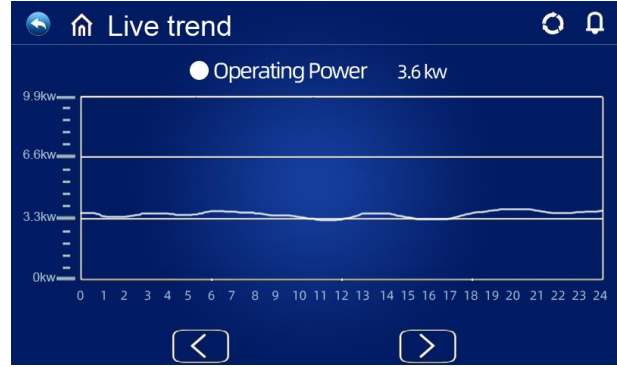
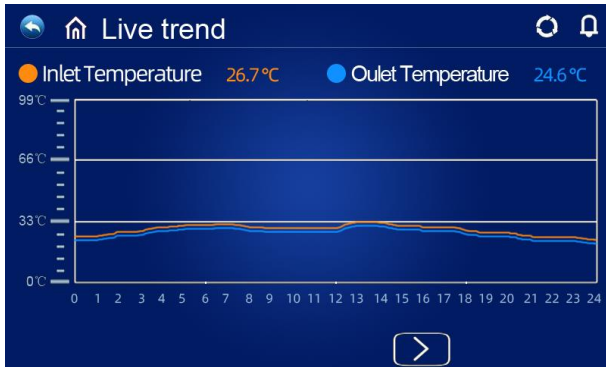

3.3.8 USER PARAMETERS QUERY & SETTING

© Press “SETTING” in the main interface to enter setting interface, then press “USER PARAMETERS” to enter parameter query and setting. Below lists shows the code, definition, range and default value.

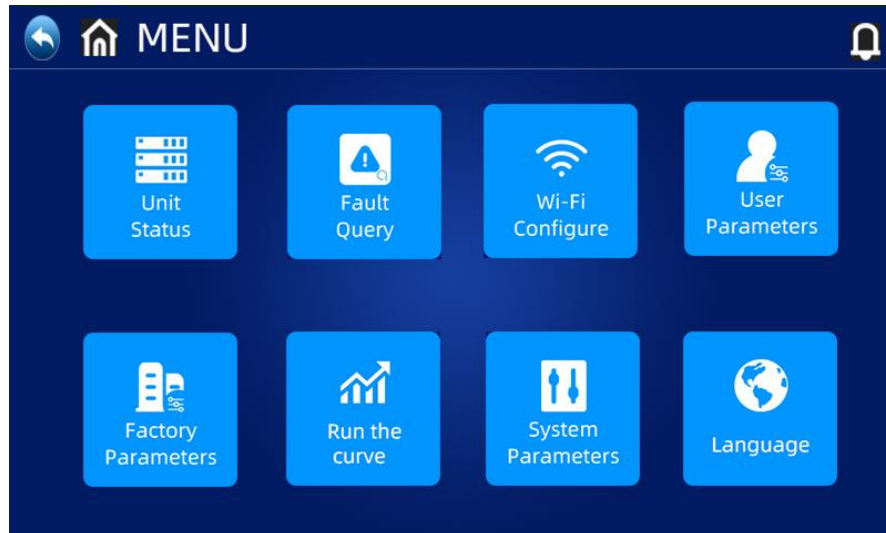

© List of user parameters

Code	Definition	Settable Range	Default
P01	Temp difference of return water and cooling target temp	2°C~18°C	2°C
P02	Temp difference of return water and hot water target temp	2°C~18°C	5°C
P03	Hot water setting temp.	28°C~70°C	50°C
P04	Cooling setting temp.	7°C~30°C	12°C
P05	Heating setting temp.	15°C~70°C	35°C

The user parameters P1-P5 can be set, and the remaining engineering parameters require a password **666** to enter the settings. It is recommended that engineers use it.

Code	Definition	Settable Range	Default
P08	Water temp. compensation	-5°C~15°C	1
P09	Defrosting frequency	30-120HZ	70HZ
P10	Defrosting period	20MIN~90MIN	45MIN
P11	Defrosting enter temp.	-15°C~-1°C	-3°C

P12	Defrosting time	5MIN~20MIN	8MIN
P13	Defrost exit temp.	1°C~40°C	15°C
P14	Defrosting environment and evaporator coil temp. difference 1	0°C~15°C	5°C
P15	Defrosting environment and evaporator coil temp. difference 2	0°C~15°C	5°C
P16	Ambient temp. for defrosting	0°C~20°C	17°C
P17	High temperature disinfection cycle days	0~30 days Disinfection function is not executed when set to 0	0
P18	High temperature disinfection start time	0~23:00	23
P19	High temperature disinfection sustaining time	0~90min	30
P20	High temperature disinfection setting temperature	0~90°C	70°C
P21	Heat pump's setting temperature for high temperature disinfection	40~70°C	65°C
P22	Heating target temperature automatic adjustment enable	0~1 (0 is not enabled, 1 is enabled) (only applicable at heating mode)	0
P23	Heating compensation temperature point (ambient temperature)	0-40	23
P24	Target temperature compensation coefficient	1~30 (1 corresponds to actual 0.1)	6
P25	Compressor's Frequency operation mode after constant Temperature	0-Non Decrease Frequency after constant Temp. /1-Decrease Frequency after constant Temp.	0
P26	Ambient temperature for starting electric heating	-20-20°C	-15
P27	Start time for electric heating of water tank	0-60 min	30
P28	On-line units	1~8	1
P29	Control address	1~255	1
P30	E-heater mode selection	0: disable 1: backup E-heater 2: water tank booster heater 3: backup e-heater + tank booster heater	0
P31	Water temperature control mode	0: Water inlet temperature 1: Water outlet temperature	0
P32	Temperature difference of compress full power operation		10
P33	Loading temperature difference		1
P34	Unloading temperature difference		1

P35	Cascade mode regulation cycle		60
P36	Automatic temperature control upper limit	20~80	70
F01	Heat Pump Function	1 Heating only 2 Heating+Cooling 3 Heating+DHW 4 Heating+Cooling+DHW	4
F02	Circulation pump status after reaching target temp.	0 Intermittent 1 All time 2 Stop at constant Temp.	0
F03	Circulation pump on-off cycle after reaching set temp.	1~120min	15 (OFF15min ON3min)
F04	DC circulation pump mode	0 No Start 1 Auto 2 Manual 3 Control water flow	3
F05	DC circulation pump adjustment cycle	10~100S	60
F06	DC water pump manual speed	10~100%	50
F08	Minimum speed of DC circulation pump	10~100%	60
S1	Smart grid capabilities	No、Yes	No
S2	SG operating time	0-600 min	180min
S3	Three-way valve status in antifreeze mode	0: three way valve is off and not active 1: three way valve is active	0
S4	Compressor restart time in dual-mode	0-5min (0-comoressor keeps running)	3
H01	Auxiliary heat source	0 disable 1 heating 2 hot water 3 heating & hot water	0
H02	Auxiliary heat source operation mode	0-low carbon mode 1-Eco hybrid mode	1
H03	Eco hybrid mode	0 fixed pricing 1 peak-valley pricing 2 ambient temp judgment	0
H04	Ambient temp of auxiliary heat source operation	-30~30℃	-15℃
H05	Delay start time of auxiliary heat source	0~180min	30min
H06	Temperature difference to enter auxiliary heat source	2~18℃	5℃
H07	Standard unit price of electricity	0~2.5RMB	0.08RMB/KWH
H08	Low valley unit price of electricity	0~2.5RMB	0.05RMB/KWH
H09	Unit price of gas materials	0~2.5RMB	0.25RMB/m3
H10	Work day low price electricity start time	0:00~23:00	0:00

H11	Work day low price electricity end time	0:00~23:00	7:00
H12	Rest day low price electricity start time	0:00~23:00	0:00
H13	Rest day low price electricity end time	0:00~23:00	23:00
H14	Ambient temp change of heat pump restart	-30~30°C	5°C
	Celsius/Fahrenheit switch	0 Celsius/1 Fahrenheit	0

3.3.9 Restore factory settings

In the upper right corner of the factory parameter R interface, there is a parameter reset factory value button. Press this button to pop up the reset parameter confirmation selection. If Yes is selected, the factory default value will be restored;

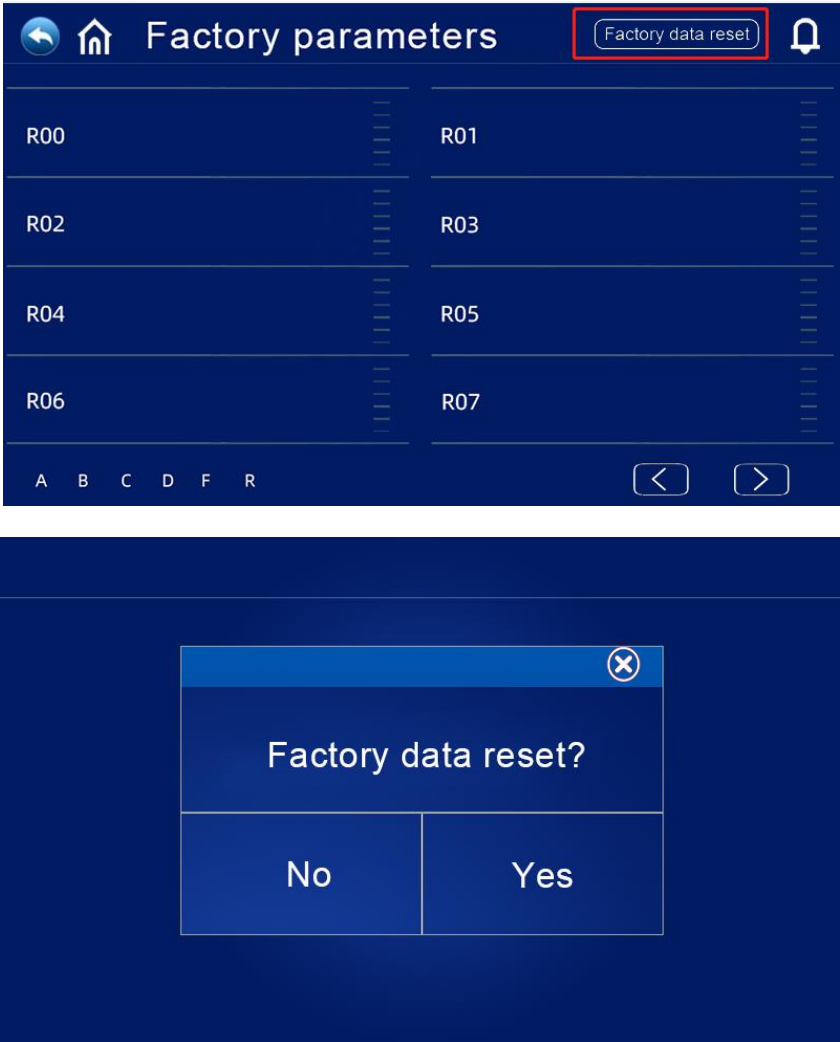

3.4 Control Logic

3.4.1 High Temperature Antisepsis Function: (under hot water mode)

- ◎ High temperature Antisepsis cycle is once every 7 (P17) days;
- ◎ When entering the high temperature Antisepsis, the water tank electric heater will be forced to turn on.
- ◎ During the Antisepsis process, if the water tank temperature > 65°C (the maximum settable temperature), then the compressor will not start, but only start electric heating; If the water tank temperature ≤ 60°C, both the compressor and electric heater will start.
- ◎ When the water tank temperature ≥ 70°C (P20) and the protection temperature lasts for 30 minutes (P19), exit the high temperature Antisepsis;
- ◎ After entering high temperature Antisepsis, if the temperature of the hot water tank does not reach 70°C after 1 hour, the high temperature Antisepsis program will be forced to exit.

3.4.2 Target Temperature Auto Adjustment Logic (under heating mode)

- ◎ The target temperature under heating mode can be automatically adjusted according to the ambient temperature.

Users can directly enter the temperature curve interface on the wired controller, set P23 and P24 parameters according to local environmental conditions, and the interface will automatically generate operating curves, as shown in the below figure.

- ◎ Entry conditions

Click on the inlet water temperature on the main interface to enter, and the maximum set temperature can be adjusted using parameter P36.

When Parameter P22=1 enables automatic adjustment mode of heating target temperature.

- ◎ Calculation formula of heating target temperature

$P_{set}(\text{heating target temperature}) = 20 + (P24/10) * (P23 - \text{current ambient temperature})$

P23 is curve slope, P24 is shift.

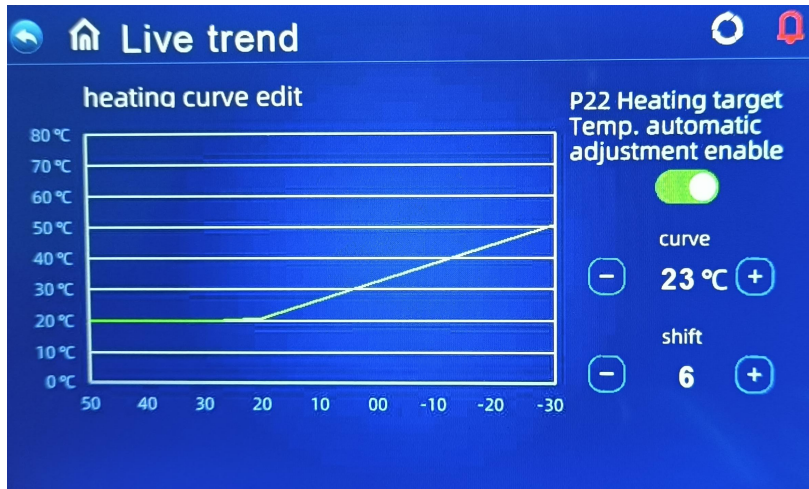

© The above different curves stands for the different value of P24.

(When P24=1, the actual value is 0.1)

© The target temperature range of automatic temperature adjustment is 20-70°C

3.4.3 Auxiliary Electric Heater for Water Tank

© Start conditions (all below conditions must be met at the same time)

- 1) In hot water mode;
- 2) The compressor runs for P27 (30) minutes;
- 3) There is a demand for hot water, and the temperature of the water tank is $\leq 55^{\circ}\text{C}$;
- 4) The pump is running
- 5) Water tank Electric heater is enabled
(P30 is set as 2 or 3)

© Exit condition (only need to meet any one of the below conditions)

- 1) When the heat pump is performing cooling mode / heating mode;
- 2) When there is no demand for hot water or constant temperature control;
- 3) The water tank temperature sensor has a fault alarm;

© When it is under defrosting / forced defrosting / secondary antifreeze , the electric heating is forced to turn on;

© When there is high-pressure failure / low-pressure failure / exhaust temperature sense failure / excessive exhaust protection stop, and if compressor is locked and cannot be started, then the electric heating will be started instead of the compressor after 5 minutes.

3.4.3 Auxiliary Electric Heater for Space heating

© Enable condition:

- 1) Under Heating mode;
 - 2) Ambient Temp. < P26 (-15°C) Or Ambient Temp. Sensor Fault
 - 3) There has Heating Demand, Inlet Water Temp. ≤ Heating Set Temp. (P05) - Restart difference (P01);
 - 4) Water pump during Working States
 - 5) Compressor was runs for P27 set minutes
 - 6) Back up Electric heater is enabled, (P30 is set as 1 or 3)
- When the above conditions are met, The Electric Heater will turn on.

© Shut-down condition:

- 1) Under Cooling or Hot Water Mode
- 2) Without Heating Demand or Constant Temp. Control
- 3) Inlet Water Temp. Sensor Failure or Alarm
- 4) Ambient Temp. > -15°C (P26) +1
- 5) Water Flow Failures
- 6) Circulation pump shut-down

E-heater be shut-down when any of above conditions met.

3.4.4 Auxiliary heat source control

The auxiliary heat source is set by parameter H01. When H01=1 operates in heating mode, the auxiliary heat source only operates in heating mode. When H01=2 operates in hot water mode, the auxiliary heat source can only be used to produce domestic hot water; When H01=3, the auxiliary heat source runs under heating & hot water mode.

When the above mode is running, the AHS will automatically turn on when the return water temperature is too low or the ambient temperature is too low, or the ambient temperature is too high (Exceeding the allowable working range of the heat pump).

When the auxiliary heat source H01 is turned on, there are two mode Settings: H02=1, operates low carbon mode; If H02=2, operates Eco hybrid mode.

1 Low carbon mode

low carbon mode refers to the calculation based on the COP with the heat pump as the priority, the auxiliary heat source as the auxiliary, and the heat pump will not stop.

Prerequisites for enabling:

1. The total outlet water temperature of the system < 70°C
2. No water flow fault occurs
3. The total outlet water temperature sensor is set enabled

1) When AHS is set to only work for heating mode or heating & hot water (H01=1 or 3)

Open conditions :(all conditions are met)

1. The total outlet water temperature of the system < [P05]-[H06]
2. Ambient temperature TA < [H04]-2

3. Hot water electric heating off time > [H05]

Closing condition: (Meet one of the conditions)

1. Total outlet water temperature > [P05]
2. Heating mode is off

2) When AHS is set to hot water mode only or heating & hot water (H01=2 or 3)

Open conditions: (All conditions are met)

1. Hot water tank temperature < [P03]-[P02]
2. Hot water tank temperature <40°C
3. Water tank electric heating closing time ≥[H05]

Closing condition: (Meet one of the conditions)

1. Hot water tank temperature ≥[P03]
2. Total outlet water temperature >70°C
3. Hot water mode is off

2 Eco hybrid mode

Eco hybrid mode relies on the COP of the heat pump for calculation, prioritize the most cost-effective mode, and the heat pump will stop if it does not save money.

There are three Eco hybrid modes: H03=1 in fixed pricing mode, H03=2 in peak-valley pricing mode, and H03=3 basing on ambient temperature

1) Fixed pricing mode

The system calculates the price of heat pump and gas every hour. When the heat pump price is lower than the auxiliary heat source, the heat pump is turned on and the auxiliary heat source is turned off. When the unit heat pump price is higher than the auxiliary heat source, the auxiliary heat source is turned on and the heat pump is turned off.

H14 Ambient temp change of heat pump restart

Based on the ambient temperature when the auxiliary heat source is turned on for the first time, when the cumulative ambient temperature changes by H14 degrees (default is 5 degrees), the heat pump is restarted to run for one hour, and then calculate the electricity price and gas price comparison based on COP, and choose whether to operate heat pump or gas boiler.

2) Peak-valley pricing mode

Calculate the unit price of electricity by time, once per hour; The time is divided into working days and rest days, working days and rest days are divided into standard electricity prices and low valley electricity prices.

The low valley electricity price is H08 and the standard electricity price is H07.

The Work day low price electricity time is H10 to H11;

The rest day low price electricity time is H12 to H13;

Prerequisites for enabling: H03 = 2 (peak-valley pricing mode)

2.1 Heating opening conditions: (all conditions are met) Turn on the auxiliary heat source and turn off the compressor.

Open conditions :(all conditions are met)

1. The total water temperature of the system < [P05]-[H06]
2. Auxiliary heat source shutdown time >5min

3. Gas use cost < heat pump use cost

Closing condition: (Meet one of the conditions)

1. The total water temperature of the system > [P05] +2
2. Heating mode is off
3. Gas use cost \geq heat pump use cost

2.2 Hot water starting conditions :(all conditions are met) Start the auxiliary heat source and shut down the compressor.

Open conditions :(all conditions are met)

1. Water tank temperature < [P03]-[P02]
2. Auxiliary heat source shutdown time >5min
3. Gas use cost < heat pump use cost

Closing condition: (Meet one of the conditions)

1. Water tank temperature \geq [P03]
2. The total water outlet temperature of the system is $\geq 70^{\circ}\text{C}$
3. Hot water mode is off
4. Gas use cost \geq heat pump use cost

3) Ambient temp judgment mode

3.1 Heating opening conditions: (all conditions are met) Turn on the auxiliary heat source and turn off the compressor.

Open conditions :(all conditions are met)

1. The total outlet water temperature of the system <[P05]-[H06]
2. Auxiliary heat source shutdown time >5min
3. Ambient temperature $T_A < H04 - 2$

Closing condition: (Meet one of the conditions)

1. The total outlet water temperature of the system >[P05] +2
2. Turn off the machine after heating
3. Ambient temperature $\geq H04$

3.2 Hot water starting conditions :(all conditions are met) Start the auxiliary heat source and turn off the compressor.

Open conditions :(all conditions are met)

1. Water tank temperature <[P03]-[P02]
2. Auxiliary heat source shutdown time >5min
3. Ambient temperature < H04 - 2

Closing condition: (Meet one of the conditions)

1. Water tank temperature \geq [P03]
2. Total outlet water temp $\geq 70^{\circ}\text{C}$
3. Hot water mode is off
4. Ambient temperature $\geq H04$

3.4.5 SMART GRID

©When the smart grid function parameter is selected to be enabled (S01 = 1), the heat pump starts running the smart grid function

SMART GRID		
Operating State	SG	EVU
Increased operation	ON	ON
	OFF	ON
Normal operation	ON	OFF
Decreased operation	OFF	OFF

1) When SG signal is on, and EVU signal is on, when the hot water mode is set to be valid, heat pump will operate hot water mode priority and the hot water mode setting temperature will be change to 70°C. (Water tank temp.) < 69, the TBH is on, (Water tank temp.) ≥ 70, the TBH is off.

2) When SG signal is off, and EVU signal is on, when the hot water mode is set to be valid and the mode is on, heat pump will operate hot water mode priority. (Water tank temp.) < P03-P02, the TBH is on, (Water tank temp.) ≥ P03+2, the TBH is off.

3) When SG signal is on, and EVU signal is off, the unit operates normally.

4) 4When SG signal is off, and EVU signal is off, the unit will not operate hot water mode, and the TBH is invalid, disinfect function is invalid. The max running time for cooling/heating is 'SG operating time', and then unit will be off.

* **TBH: Water tank heater**

3.5 General Operating Guide

Initial Start-up Precautions

First boot-strap and Running state checks

1. To ensure the power same as the product nameplate required power.
2. Unit electrical connections: Check if power supply wire track and connection is ok; if ground wire is properly connected; Check if water pump and other chain device is properly connected
3. Water pipe and pipe: water pipe and pipe must be washed two and three times, ensure clean and no any pollution.
4. Check water system: If the water is enough and no any air, ensure no leakage
5. First boot-strap or starting up again after long time stop, ensure power on ahead and heating at least 12 hours for crankcase (local loop temp. is zero). Water pump start up first, last a while, fan start up, compressor start up, unit regular work.
6. Running checks (according to the following data to check if the unit running is normal)
After unit normal running, check the following item:
 - a. Input and output water temp.
 - b. cycle water flow of the side
 - c. running electric current of compressor and fan

d. High and low pressure value when heating running.

 **CAUTION** — Refrain from using this heat pump if any electrical components have been in contact with water. Immediately call a qualified service technician to inspect the heat pump.

 **CAUTION** — Keep all objects clear above the heat pump. Blocking air flow could damage the unit and may void the warranty.

3.6 Users Guide

1. Rights and Responsibility

1.1 To ensure you have the service in guarantee period, only the professional server and technology staff can install and repair the unit. If you infract this request and cause any loss and damage, our company will not be claimed any responsibility.

1.2 After receiving the unit, check if have damage on shipment and all parts are complete; any damage and lack of parts please notice the dealer in written.

2. User Guide

2.1 All safety protection device are set in unit before leaving factory, don't adjust by yourself.

2.2 Unit have enough refrigerant and lubricating oil, don't fill or replace them; if need fill owing to leak, please refer to the quantity on nameplate (if refill refrigerant, need re-vacuum).

2.3 External water pump must connect with the message of unit, or else easy show various water lack alarm.

2.4 Regular clean water system according to maintenance request.

2.5 Pay attention to antifreeze when the environment temp. is less than zero in winter.

2.6 Safety Precautions

A User can't self-install the unit, ensure agent or specialized install company to do, or else maybe cause safety accident and affect the use effect.

B When install or use the unit, please check if the power is corresponding with unit power.

C The main power switch of unit should install leakage protector; the power cord must meet unit power request and national standard and local Fire & Safety Regulations.

D Unit must have ground wire; don't use the unit if no ground wire; forbid connect the ground wire to null line or water pump.

E The main power switch of unit should set much higher 1.4 meter (child don't touch it), to prevent child play it and cause danger.

F More than 52°C hot water can cause damage, hot and cold water must be mixed then use it.

G When unit is soaking, please contact the factory or maintain department, you can use it again after maintain.

H Forbid insert any tools into fan fence of unit, fan is dangerous. (child special care)

I Don't use the unit if turn off the fan fence.

J To avoid electric shock or cause fire, don't store and use fixture, oil paint and petrol etc. combustible gas or liquid around the unit; don't throw the water or other liquid on the unit and don't touch the unit by wet hand.

K Don't adjust the switch, valve, controller and internal data except company server or authorized staff.

L If safety protection device often start up, please contact factory or local dealer.

Section 4

General maintenance

4.1 Controller Error Codes

If there's error in the heat pumps, the error code and error definition will be displayed in the main interface, and saved the record in FAULTY column inside the SETTING interface.

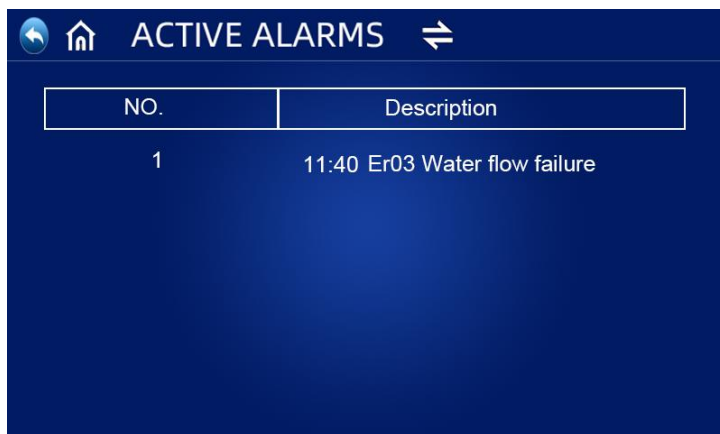

The following Common Error Codes will be displayed on the controller panel:

Error Code	Definition of Error or Protection
Er 01	Power supply phase loss
Er 03	Water flow failure
Er 04	Antifreeze in winter
Er 05	High pressure fault
Er 06	Low pressure fault
Er 09	Communication failure
Er 10	Communication failure of frequency conversion module (alarm when communication between outer board and drive board is disconnected)
Er 12	Exhaust temp too high protection
Er 14	Water tank temp. sensor fault
Er 15	Water inlet temp. sensor fault
Er 16	Evaporator coil temp. sensor fault
Er 18	Exhaust temp. fault
Er 20	Abnormal protection of frequency conversion module
Er 21	Ambient temp. sensor fault
Er 23	Cooling outlet water temp. Super-cooling protection

Er 26	Heat sink temp. fault
Er 27	Outlet water temp. sensor fault
Er 29	Return gas temp. sensor fault
Er 32	Heating too high outlet water temp. protection
Er 33	Coil temp. too high
Er 34	The temp. of frequency conversion module is too high
Er 42	Cooling coil temp. sensor failure
Er 62	Inlet temp. fault of economizer
Er 63	Outlet temp. failure of economizer
Er 64	DC fan 1 fault
Er 66	DC fan 2 fault
Er 67	Low pressure switch failure
Er 68	High pressure switch failure
Er 69	Too low pressure protection
Er 70	Too high pressure protection
Er 72	Fan drive board communication error
Er 73	Expansion board communication error
Er74	Total outlet water temp. Sensor failure

When there's Er 20 error in the system, it will display below detailed error code from 1 to 348. Among them, 1~128 are in the first class, when will be displayed as priority, 257~384 are in the second class, which will be displayed only when error 1~128 don't appear. If 2 or more than 2 error occurs simultaneously in the same class, then it will display the sum of the error number. For example, when 16 and 32 exist at the same time, then it will display error code 48 (16+32=48)

Detailed error code list for Er 20:

Error Code	name	description	Solution suggestion
1	IPM (Inverter Power Modul) Over-current	<ol style="list-style-type: none"> 1. The IPM overloaded or overheated 2. The U,V,W driver short-circuited 3. The IPM module fault 4. The compressor damaged 	<ol style="list-style-type: none"> 1 Ensure that the ring temperature, water temperature, water flow, etc. are within the operating range of the unit; 2. Use a multimeter to measure the motor U,V,W in ohmic gear to ensure no short circuit 3. Replace the frequency conversion module 4. Replace the compressor

2	compressor synchronous abnormal	<ol style="list-style-type: none"> 1. The compressor overloaded instantaneously 2. The compressor does not match the program 3. The difference between high and low pressure starts the compressor excessively 	<ol style="list-style-type: none"> 1. Ensure that the ring temperature, water temperature, water flow, etc. are within the operating range of the unit; 2. Replace the driver board with the correct program 3. Ensure that the high and low pressure difference starts normally
8	compressor output phase absent	<ol style="list-style-type: none"> 1. The U, V, and W cables of the compressor are missing or improperly connected 2. The compressor does not match the program 3. The difference between high and low pressure starts the compressor excessively 	<ol style="list-style-type: none"> 1. Check whether the U, V, and W wires of the compressor are missing or in poor contact 2. Update the driver 3. Ensure that the high and low pressure difference starts normally
16	DC bus low voltage	<ol style="list-style-type: none"> 1. The power supply unstable 2. AC suddenly power off, the inverter capacitor residual power supply chip detects that the DC voltage will be too low 3. The PFC module fault 	<ol style="list-style-type: none"> 1. Ensure that the power supply is stable 2. Check the capacitor after it is powered off 3. Replace the faulty frequency conversion module
32	DC bus high voltage	<ol style="list-style-type: none"> 1. The power supply voltage too high. 2. The capacitor fault 3. The PFC module fault 	<ol style="list-style-type: none"> 1. Ensure that the power supply voltage is normal 2. Replace the capacitor 3. Replace the faulty frequency conversion module
64	Radiator over temperature	<ol style="list-style-type: none"> 1. The fan on the host is faulty 2. The air duct is blocked 	<ol style="list-style-type: none"> 1. Check and replace the fan 2. Ensure proper ventilation
128	Radiator temperature error	<ol style="list-style-type: none"> 1. The heat sink sensor is short-circuited or open 2. Heat sink fouling 3. The ambient temperature too high 	<ol style="list-style-type: none"> 1. Replace the frequency conversion module 2. Remove dust and scale from the heat sink 3. Lower the ambient temperature
257	communication failure	<ol style="list-style-type: none"> 1. The connector of the communication cable between the main board and the driver board is in poor contact or falls off 2. Internal components of the heat pump damaged 3. The output voltage of the power supply board in the module abnormal or no output 	<ol style="list-style-type: none"> 1. Reconnect and ensure stability 2. Replace the internal components 3. Replace the power module
258	AC Input phase absent	Input phase absent (Three phase module is effective)	Inspection input circuit
260	AC Input over-current	Input three phase imbalance (three phase module is effective)	Inspection input three phase phase voltage
264	AC Input low voltage	<ol style="list-style-type: none"> 1. The input voltage too low 2. The current transformer damaged during transportation 	<ol style="list-style-type: none"> 1. Ensure that the input voltage is normal 2. Ensure that the current transformer works properly
288	IPM too high temperature	<ol style="list-style-type: none"> 1. The fan is faulty or the air duct blocked 2. The ring temperature rises too fast, resulting in over-temperature drop too late to react 	<ol style="list-style-type: none"> 1. Replace the fan 2. Ensure that the air duct unblocked 3. Reduce the ring temperature 4. Ensure that the power supply

		3. The power supply voltage and current too high or too low	voltage and current are normal
320	Compressor peak current too high	1. Compressor load is too large; 2. The driver board is faulty 3. The compressor is damaged	1 Ensure that the ring temperature, water temperature, water flow, etc. are within the operating range of the unit; 2. Replace the compressor driver plate. 3. Replace the compressor

4.2 Owner Inspection

We recommend that inspections on heat pumps are done frequently, especially after abnormal weather conditions. The following basic guidelines are suggested for your inspection:

1. Make sure the front of the unit is accessible for future service.
2. Keep the top and surrounding areas of the heat pump clear of all debris.
3. Keep all plants and shrubs trimmed and away from the heat pump especially the area above the fan.
4. Keep lawn sprinklers from spraying on the heat pump to prevent corrosion and damage.
5. Ensure that the ground wire is always properly connected.
6. The filter must be maintained on a regular basis in order to ensure clean and healthy water to protect the heat pump from damaging.
7. Keep inspecting power and electrical components' wiring to make sure their normal operation.
8. All the safety protection devices have been set up; please refrain from changing these settings. If any changes are needed, please contact the authorized installer/agent.
9. If the heat pump is installed under roof without a gutter, ensure that all measures are taken to prevent excessive water from flooding the unit.
10. Do not use this heat pump if any electrical part has been in contact with water. Contact an authorized installer/agent.
11. If the increase of power consumption is not due to colder weather, please consult with the local authorized installer/agent.
12. Please turn off the heat pump and disconnect it from the mains power supply, when not in use for a prolonged period of time.

4.3 Troubleshooting

Use the following troubleshooting information to resolve issues/problems with your DC Inverter heat pump.

WARNING — RISK OF ELECTRICAL SHOCK OR ELECTROCUTION.



Ensure that all high voltage circuits are disconnected before commencing heat pump installation. Contact with these circuits could result in death or serious injury to users,

installers or others, due to electrical shock and may also cause damage to property.

DO NOT opens any part of the heat pump as this may result to electrocution.

1. Keep your hands and hair clear of the fan blades to avoid injury.
2. If you are not familiar with your heater:
 - a) **DO NOT** attempt to adjust or service the unit without consulting your authorized installer/agent.
 - b) **PLEASE** read the complete Installation and/or User's Guide before attempting to operate service or adjust the heater.

IMPORTANT: Turn off the mains power supply to the DC Inverter heat pump prior to attempting service or repair.

4.4 Maintenance

The DC Inverter air source heat pump unit is highly automation device. If the units are cared and maintained effectively regularly , the operation reliability and the lifetime of the unit will be highly improved.

Important tips below shall be paid more attention to when doing the maintenance:

1. The water filter shall be cleaned termly, to make sure the water is clean, and avoid any damage caused by the filter blockage.
2. All the safety protection device set up already before leaving the factory, forbid to adjust by oneself. We could not take any responsibility for any unit damage caused by the user's self-adjustment.
3. The surrounding of the unit shall be clean, dry and draughty. If the side of the heat exchanger could be cleaned termly(every 1-2 month), the heat exchanging efficiency will be better, and energy saving.
4. The water supplement of water system and air discharge device shall be checked frequently, to avoid the air to enter the system, causing the water circulation decrease, or the water cycle trouble, or it will effect the unit's cooling, heating efficiency and the working reliability .
6. 5. The power of the unit and the electrical wiring shall be checked frequently, make sure the wiring is fastened and the electrical component is normal. If abnormal, it shall be repaired or replaced, the unit shall be connected to the ground reliably.
7. Check every components during the unit operation frequently. Check whether the working pressure of cooling system is normal or not. Check the pipe splice and the air injection valve whether have greasy dirt. Make sure not any refrigerant leakage in the cooling system.
7. Don't stack any sundries around the unit, in case blocking the air inlet and outlet. The surrounding of the unit shall keep clean, dry and draughty.
8. The water in the water system shall be discharged if the unit need to take a long break after running for a period. And the power shall be off, put a cover on the unit. Only after the water system is replenished full with water and the unit is checked roundly, and the unit is power on to warm up for at lease 6 hours, all is fine, then the unit could be started up again.

Notice:

The unit should be equipped with the dedicated power supply. The voltage range should be within $\pm 10\%$.

The switch should be automatic air switch. The setting electric current should be 1.5 times of the running current, and equipped with lack of phase safeguard. The knife switch is forbidden to use in the unit.

The unit must be power on to warm up for at least 12 hours before running every season. If the cooling only models haven't been working for long term in winter, make sure to discharge out all the water, in case the pipe and the unit are damaged by frost. The master controller and the unit should be in correspondence and couldn't be power off if the heating only models stop working for long term in winter, to avoid the frost damage.

The heat pump switch couldn't be operated frequently, can not be over 4 times within one hour. The electric cabinet shall prevent to be affected with damp.

Forbid to flush the DC inverter air source heat pump with water, avoid any electric shock or other accidents.

4.5 Common Faults and Debugging

©The user must hire the professional maintenance staff to fix if the unit has any problems during working. The maintenance staff might refer to the chart to debug.

Error Status	Possible reason	Solution
Heat pump not running	Power fault Wiring loose Fuse blow fused Thermal Overloaded protector off Low pressure too low	Put off the power switch, check the power supply find out the causes and repair Replace the fuse blow test the voltage and current
Water pump is working but without water cycle or water pump high noise	Lack of water in the system with air in the water system the valves are not all open filter is dirty and blocked	Check the system replenishment device and replenish the system discharge the air in the water system Open the water system valve Clean the water filter
Low heating capacity	Lack of refrigerant Bad heat preservation of water system; Dryer filter blocked Bad heat dissipation of air heat exchanger Not enough water flow	Leakage detecting and supply refrigerant Reinforce the heat preservation of water system Change the dry filter Clean the air heat exchanger Clean the water filter
Compressor not working	Power failure; Contactor of compressor damage; wiring loose Compressor overheat protection outlet water temp. Too high; Not enough water flow Compressor overload protector tripped	Find out the causes and solve the power failure Change the contactor of compressor Find out the loose point and repair Check the unit refrigerant pressure and discharge line temp. Reset the outlet water temp Clean the water filter and discharge the air in the system Check the running current and whether overload protector damage

compressor running noise too high	Liquid refrigerant enter the compressor The inner parts of compressor damage Too Low voltage	Check the expansion valve whether out of effect Replace the compressor Check Power Voltage
Fan not working	The fastening screw of the fan loose Fan motor damage Contactor damage	Reinforce the screw Replace the fan motor Replace the contactor
Compressor running but heat pump not heating	Refrigerant is all leaking out Compressor fault Compressor reversal	Check leakage and the refrigerant pressure Replace the compressor Exchange the phase order of compressor
Low water flow protection	Not enough water flow in the system Water switch fault	Clean the water filter and discharge the air in the system Check the water switch and replace it

Section 5 WIFI Connection and Operation

5.1 APP Download

©Please go to “Google Play Store” or “Apple App Store” and search “Smart Life” or “Tuya Smart” then download. See below figures.

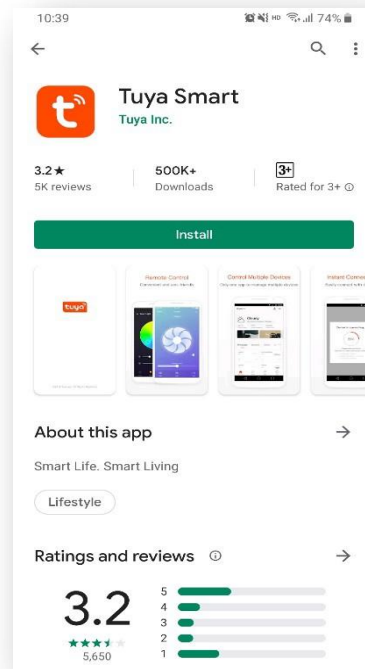
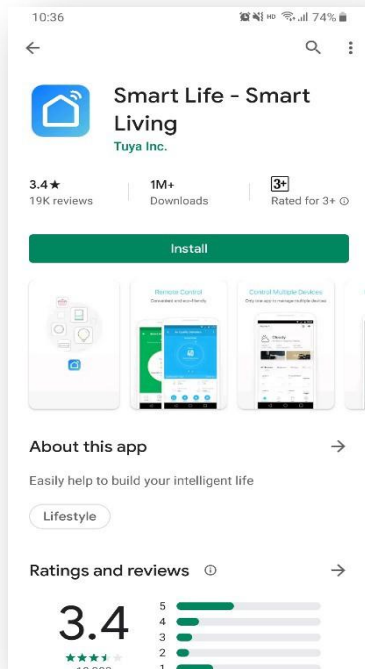

5.2 WIFI Connect Method : bluetooth mode:

The 1st step:

©By default, it can be connected within 10s after the first power-on, and it needs to be connected by pressing buttons after 10 seconds. (10s is the delay for wifi to enter low power consumption)

©Manually enter the smart distribution mode: select "SMART MODE" or "AP MODE" on the WIFI interface of the wired controller, click "Add Device" to enter the smart distribution mode, the "📶" icon on the main interface flashes, and the mobile phone can start to configure the network.



©Exit the network configuration status after 3 minutes, the "📶" icon stops flashing, and the WIFI module is no longer networked. If you want to configure the network again, you need to click the "Add Device" button on the WIFI interface again.

The 2nd step:

©Turn on the phone's bluetooth

©Turn on the WIFI function of the mobile phone and connect to the WIFI hotspot. The WIFI hotspot must be able to connect to the Internet normally, as shown in the figure: Connect the WIFI hotspot "123456789".

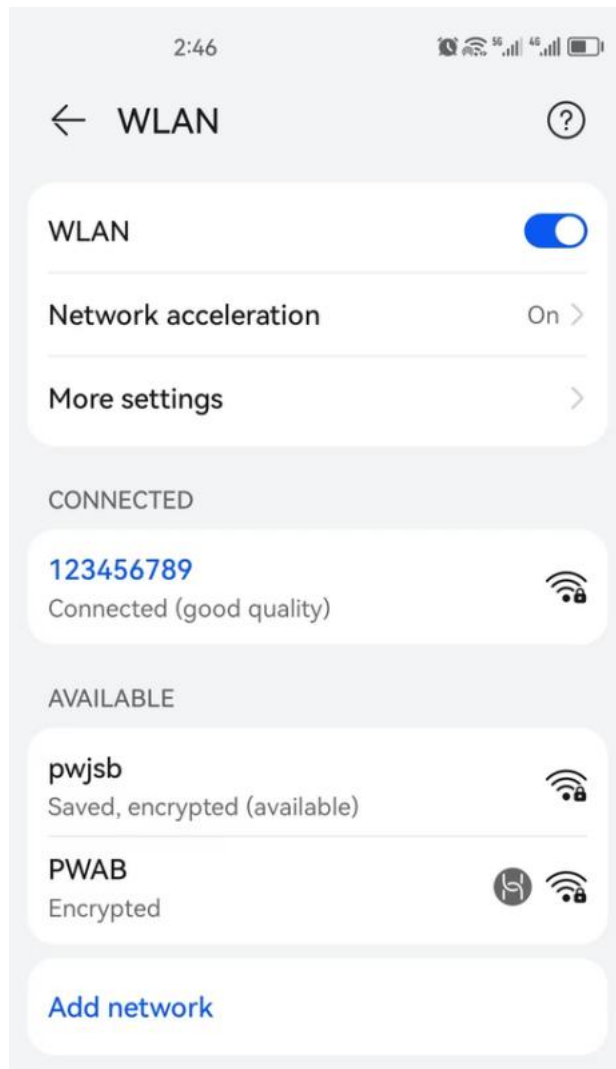

The 3rd step:

©Open the "Smart Life" APP, login and enter the main interface, click "+" in the upper right corner or "Add Device" on the interface ,The Interface shows Findings"Discovering devices"...,Click"Add" To Entering "Add Device" Interface , click "+", Then Select WIFI in the Network selection interface,Input & Confirm the Correct Wifi Password, Click"Next" to Start Matching Wifi.

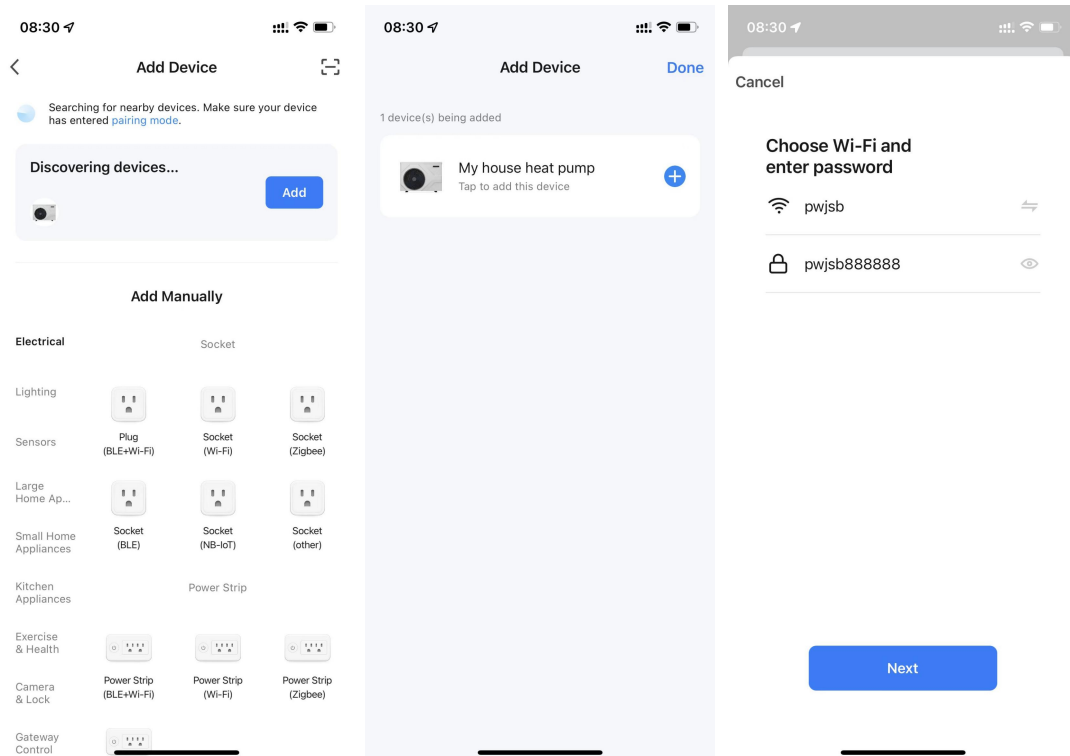

The 4th step:

© When the connection is successful and the system prompts "Added successfully", then the network configuration is successful. Click "Done" to entry Homepage

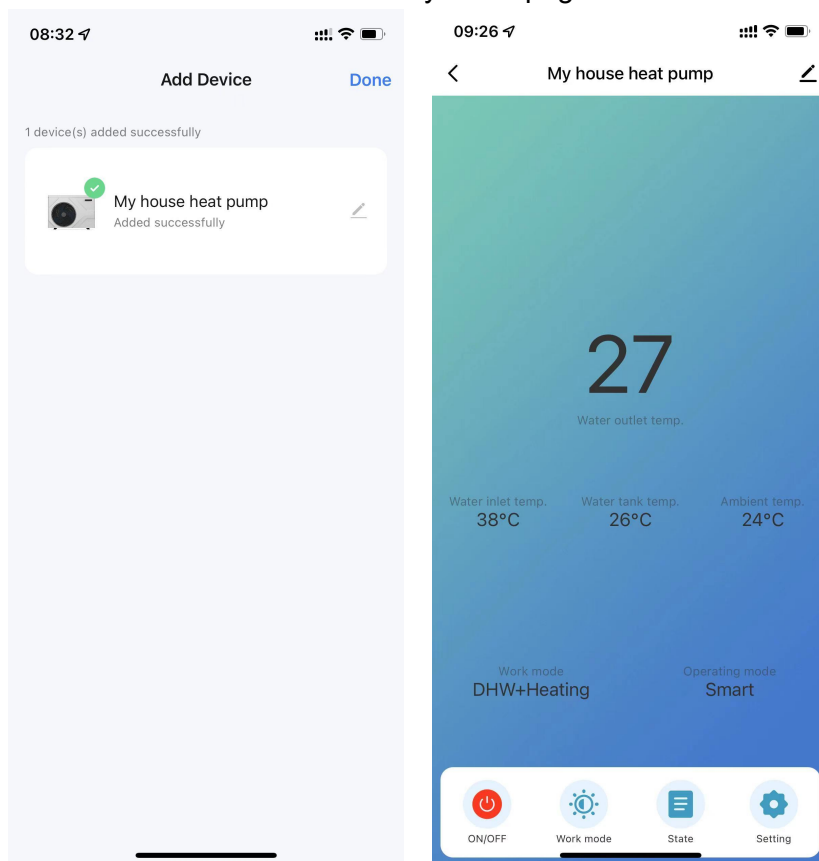

5.3 Software function operation

Interface Introduction

©After the device is successfully bound, enter the "My house Heat Pump " (device name can be modified) operation page.

©Click "My house Heat Pump" in "All Devices" in the main interface of "Smart Life" APP to enter the "My house Heat Pump" device's operation page.

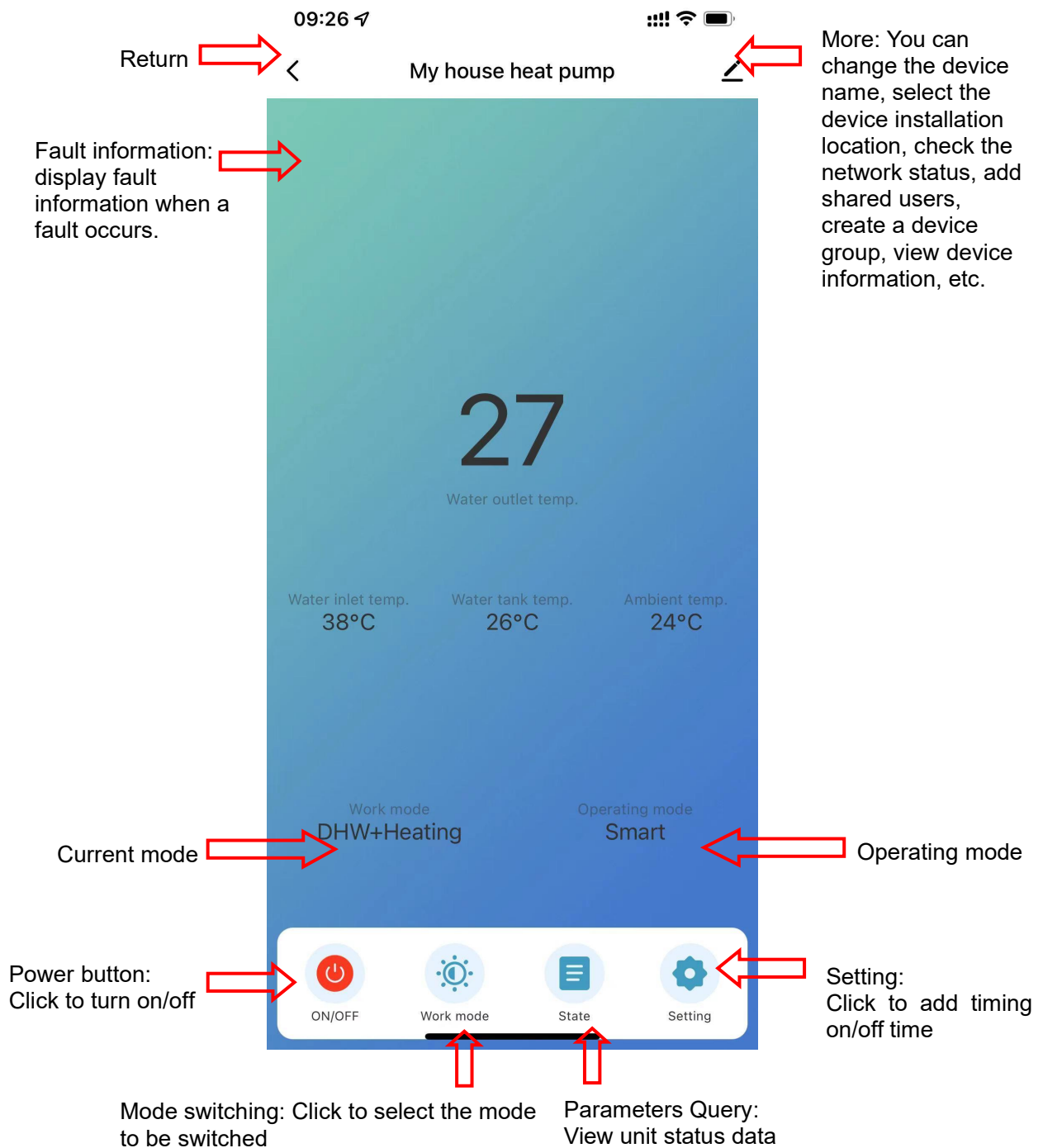

Mode setting

©Click "Work mode" on the main interface of the equipment operation to switch mode, and the mode selection interface will pop up as shown in the figure below, just click the mode you need to select.

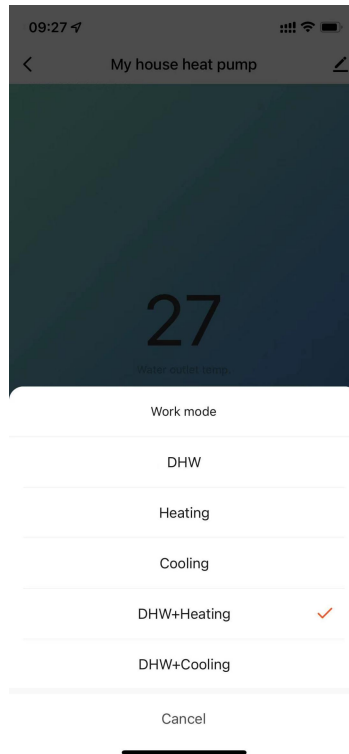

Water Temp. Setting

©In the Setting interface, click "Water Temp. Setting" to set the Desired Temp. And Return difference Temperature

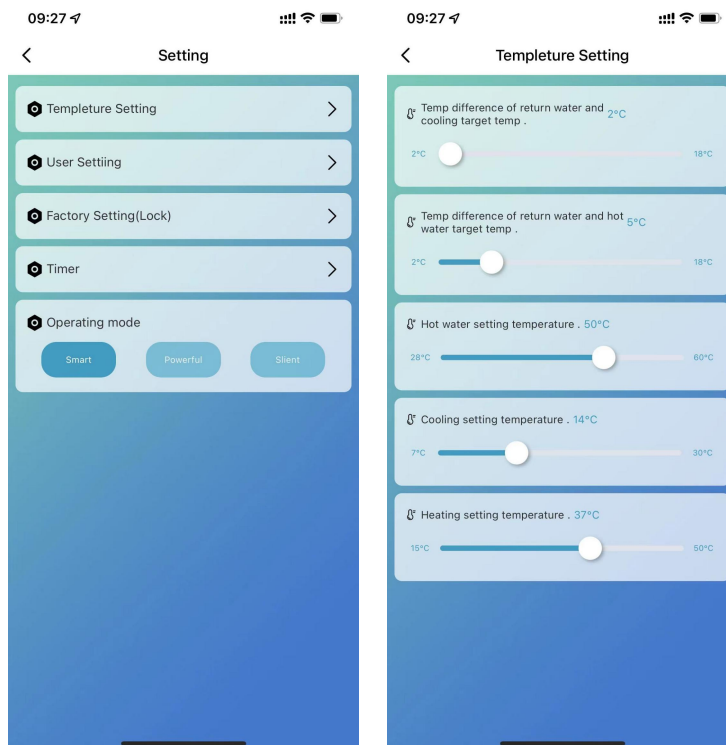

User setting

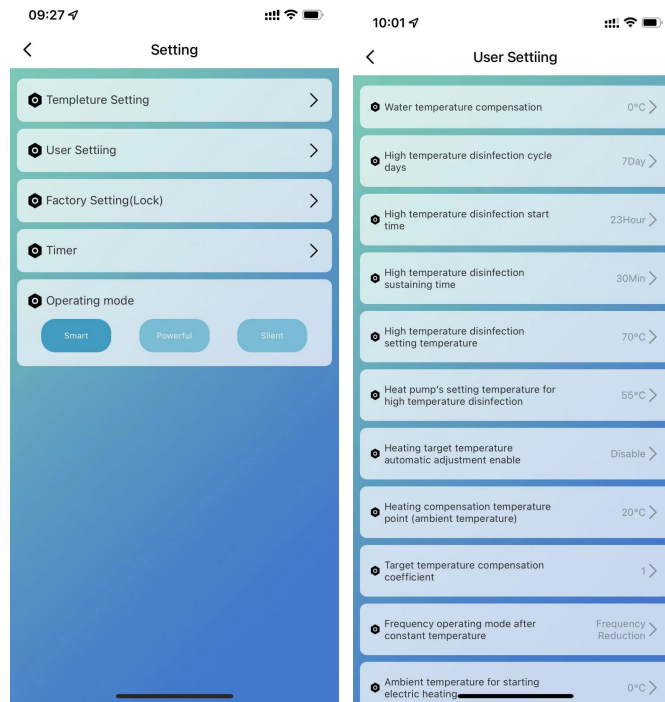

Timer setting

© In the Setting interface, click "timing" to enter timer setting, click to add timer.

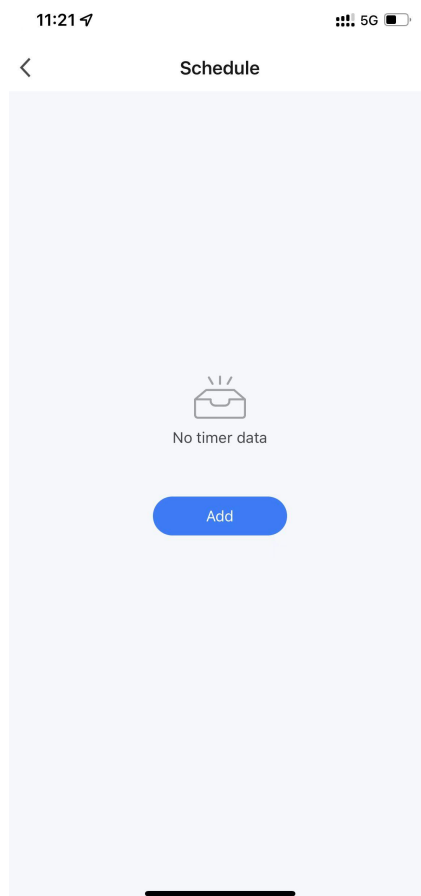

© In the timer setting, slide the hour/minute up and down to set the timer time, and set the repeating week and on/off, press the upper right corner to save, as shown in the below Fig.

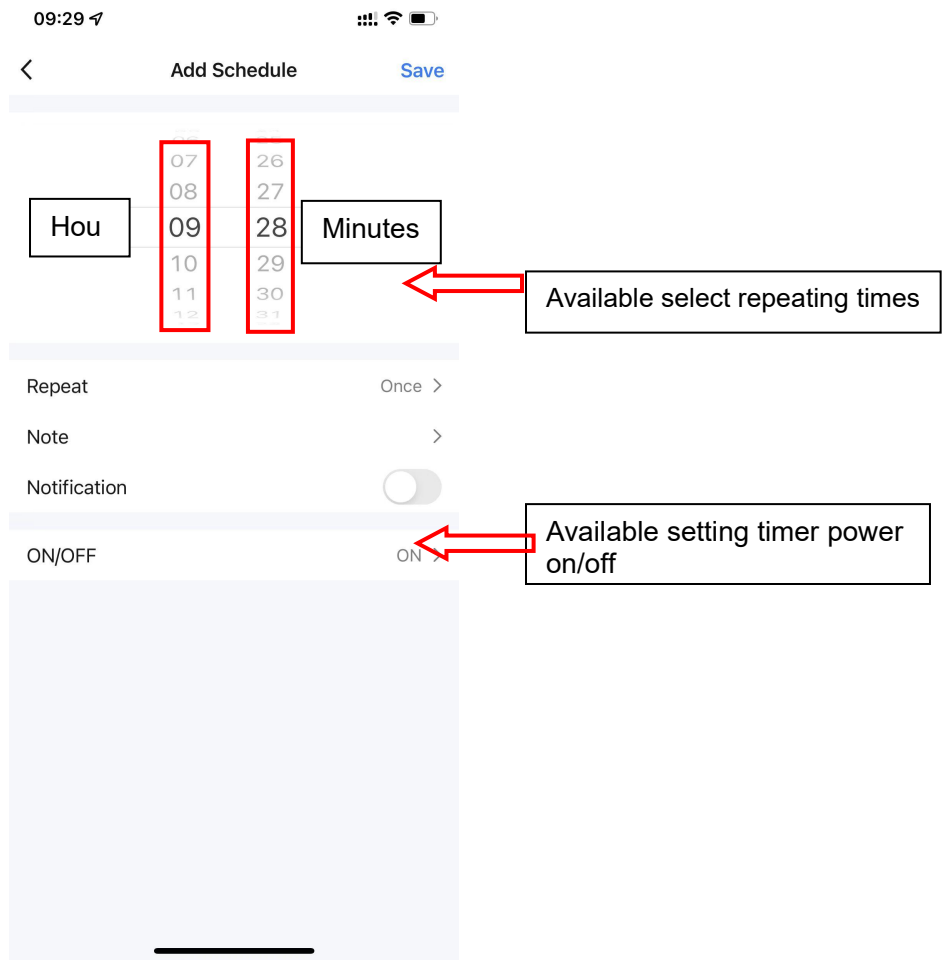

Power Consumption Curve View

© In the Setting interface, click "Power Statistics Module" to enter the power consumption curve interface.

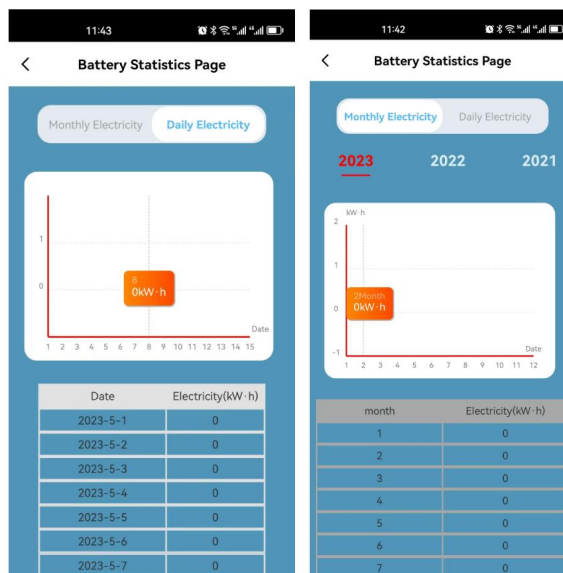

Equipment sharing

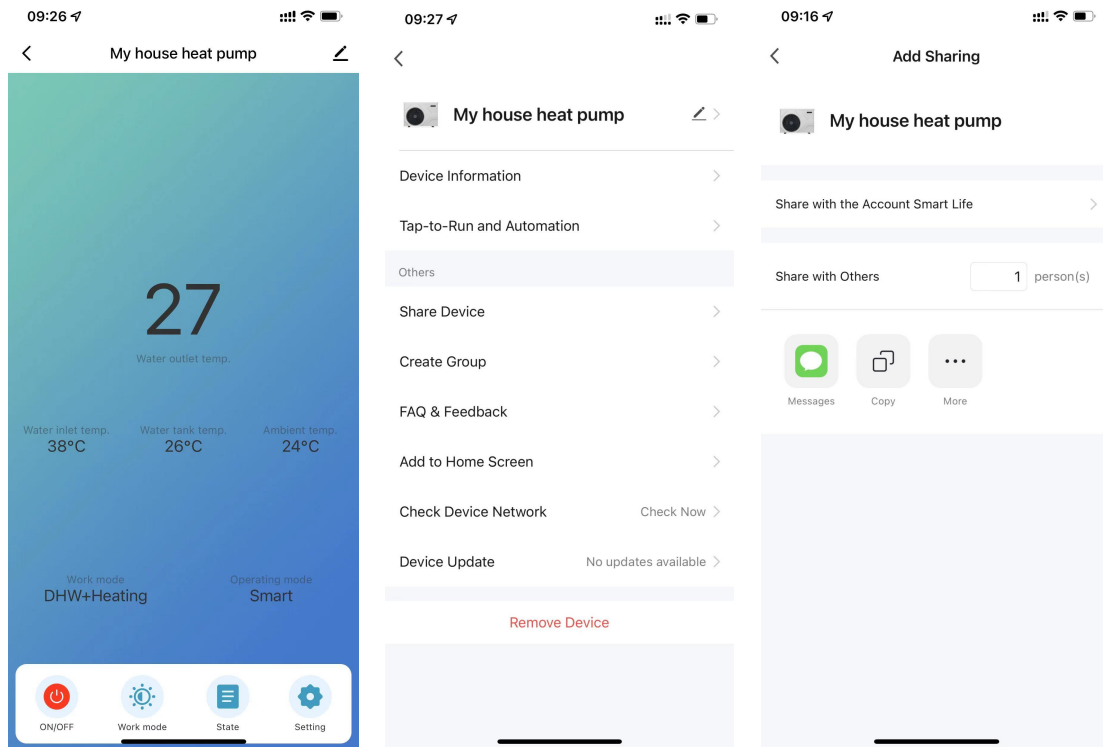

- ◎ Share the bound device, the sharer operates in the following sequence.
- ◎ After successful sharing, the list will be increased and show the shared person.
- ◎ To delete the shared person, long press the selected user, the delete interface will pop up, click "Delete".
- ◎ The operation of the sharing interface is as follows:



- ◎ Input the account of the shared person, click "Done", the shared success list will display the account of the newly-added shared person. The shared person showing the received shared device, click in to operate and control the device.

Device removal

◎ APP removal

Click  in the upper right corner of device operation main interface to enter device details interface, and click "Remove Device" interface to enter the intelligent network configuration mode. "" Corresponding indicator light does not flash, and the network can be reconfigured within 3 minutes. If it exceeds 3mins, it will exit the distribution network.